

POZO SÉPTICO ABSORBENTE D=2,0 M ESC 1:25

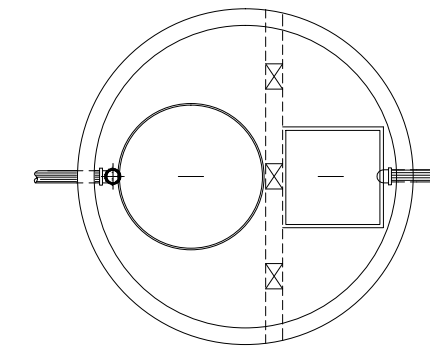

REFERENCIAS -

- TAP-PVC TUBERIA DE AGUA FRIA DE PVC
- TAC-HIDRO3 TUBERIA DE AGUA CALIENTE
- ⊗ LLAVE DE PASO
- ⊞ MEDIDOR DE AGUA
- ⊞ CODO DE 90°
- ⊞ CODO DE 45°
- ⊞ TEE

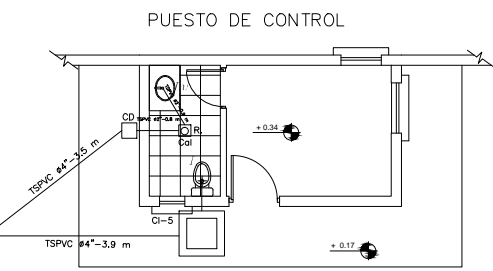
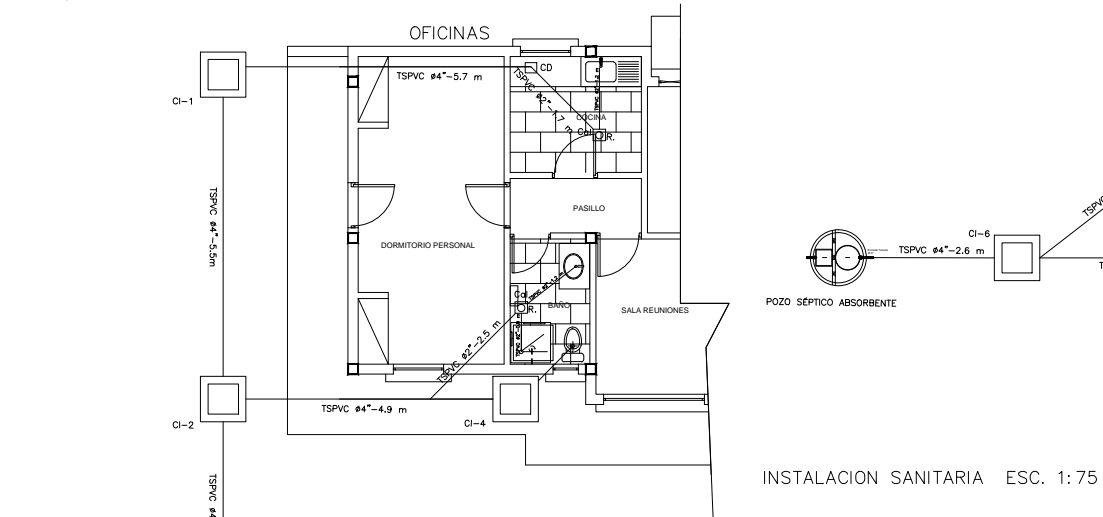
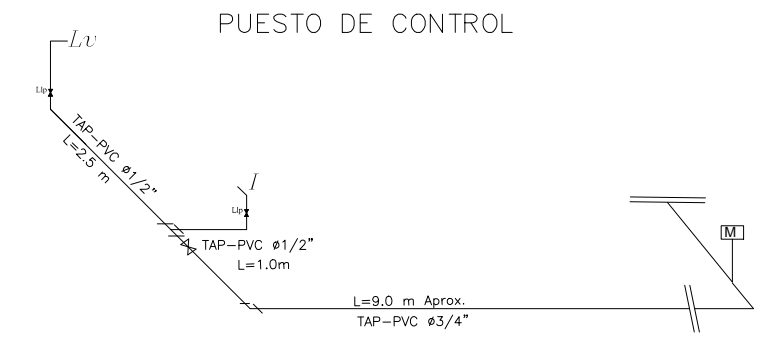
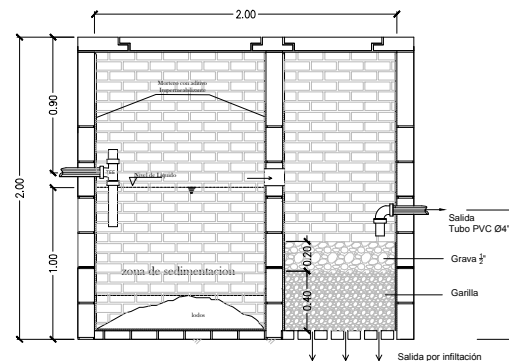

POZO SÉPTICO ABSORBENTE D=1,5 M ESC 1:25

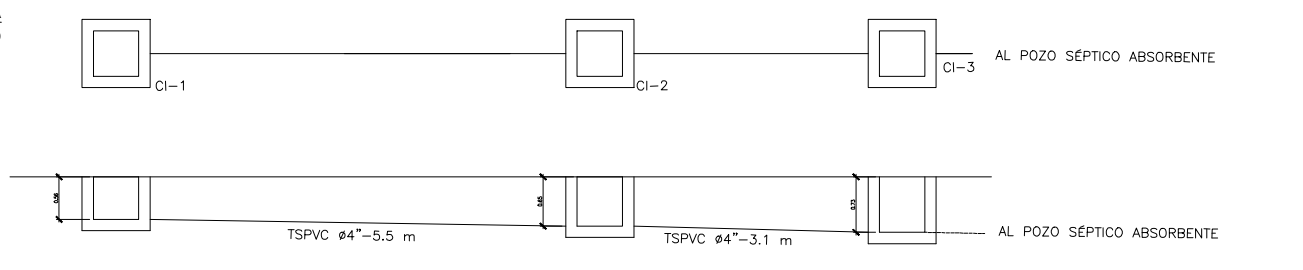
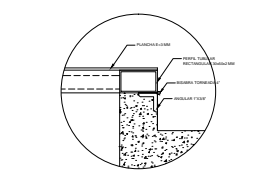
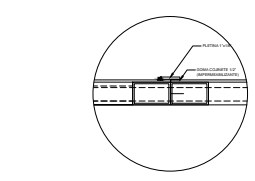
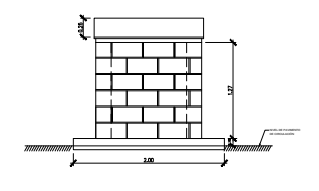
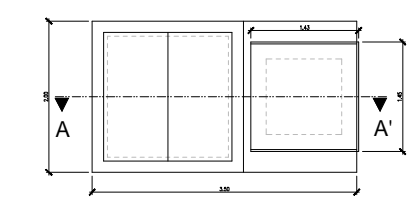
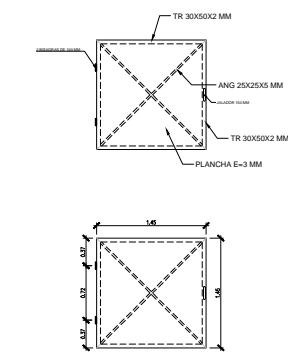
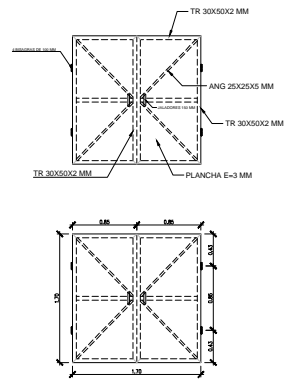
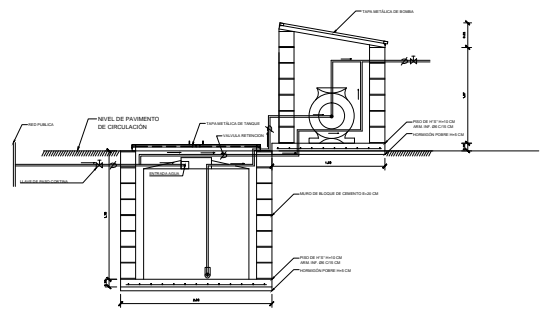
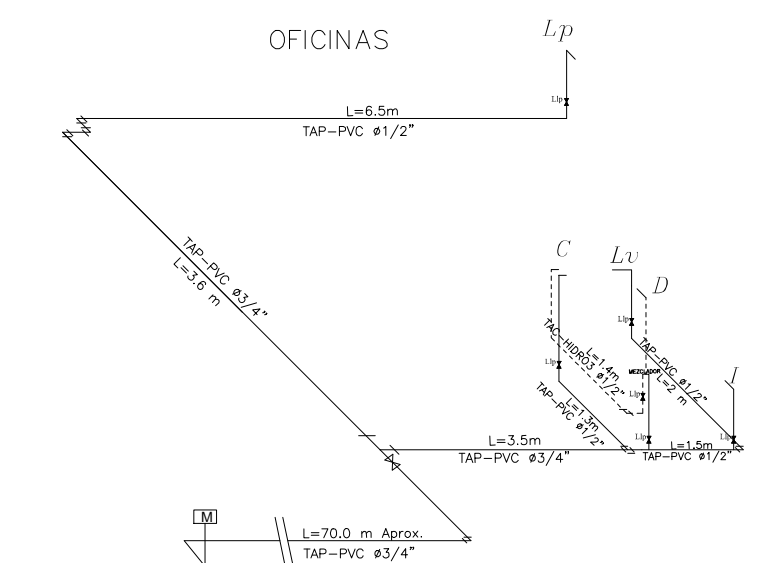
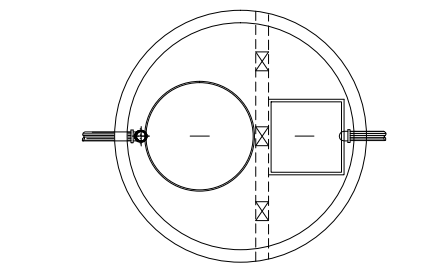

CONSULTOR DE LINEA:		UBICACION:		PROPIETARIO:		OBRA:			
		DEPARTAMENTO	LA PAZ	 YACIMIENTOS PETROLIFEROS FISCALES BOLIVIANOS GERENCIA NACIONAL DE REDES DE GAS Y DUCTOS DIRECCION GAS VIRTUAL		PROYECTO CONSTRUCCION DE OBRAS CIVILES COMPLEMENTARIAS DE ESR GUANAY - PROYECTO GNL			
		PROVINCIA	LARECAJA			DESCRIPCION: PLANO DE AGUA POTABLE Y SANITARIO			
		MUNICIPIO	GUANAY			ESPECIALIDAD:	FECHA:	ESCALA:	LÁMINA:
					SANITARIA	SEPTIEMBRE 2015	INDICADAS	1/1	