 La fuerza que transforma Bolivia	YACIMIENTOS PETROLÍFEROS FISCALES BOLIVIANOS GERENCIA DE REDES DE GAS Y DUCTOS DISTRITO REDES DE GAS ORURO	Anexo 2
	GRAFICOS	Hoja: 1 de 15

GRÁFICOS

1. LETREROS

1.1. LETREROS DE SEÑALIZACIÓN - HOMBRES TRABAJANDO.

(ESTRUCTURA METÁLICA, 850 mm de ancho por 1300 mm de alto)

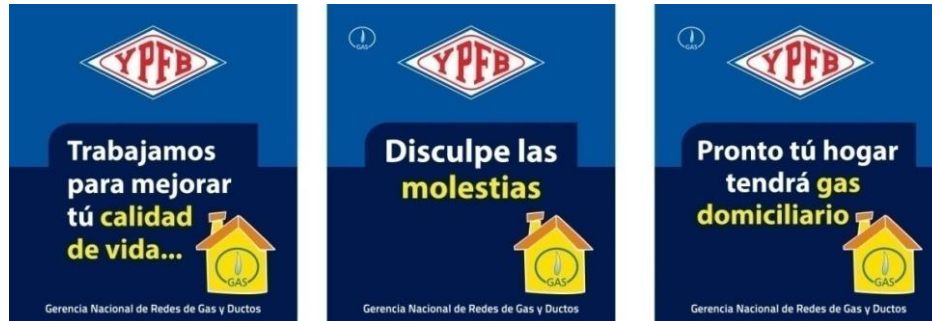

Elaborado y Revisado por:	Aprobado por:

 La fuerza que transforma Bolivia	YACIMIENTOS PETROLÍFEROS FISCALES BOLIVIANOS GERENCIA DE REDES DE GAS Y DUCTOS DISTRITO REDES DE GAS ORURO	Anexo 2
	GRAFICOS	Hoja: 2 de 15

1.2. LETRERO DE OBRA. (De acuerdo a especificación, 2,8 m de ancho por 2,0 mm de alto)

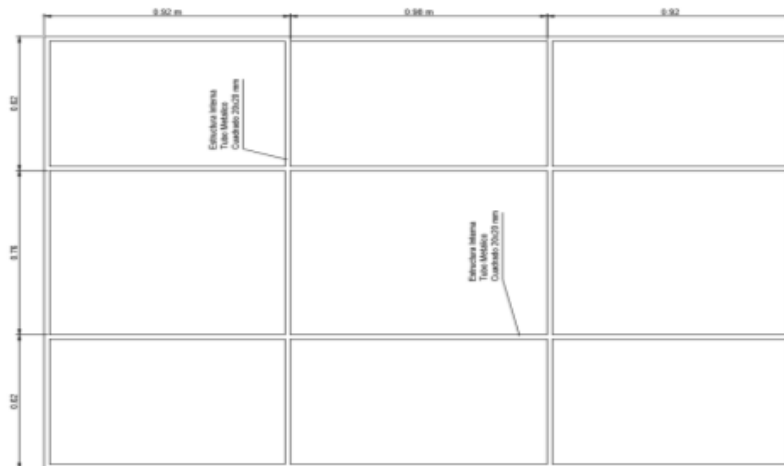

Elaborado y Revisado por:	Aprobado por:



2. EXCAVACIÓN DE ZANJAS

2.1. ACERAS

TERRENO BLANDO

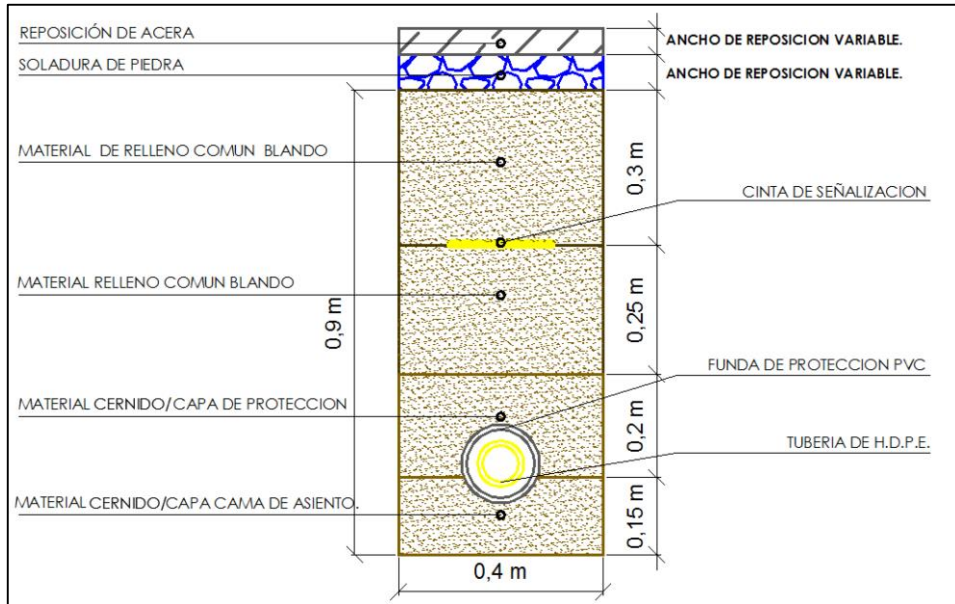

TERRENO SEMIDURO

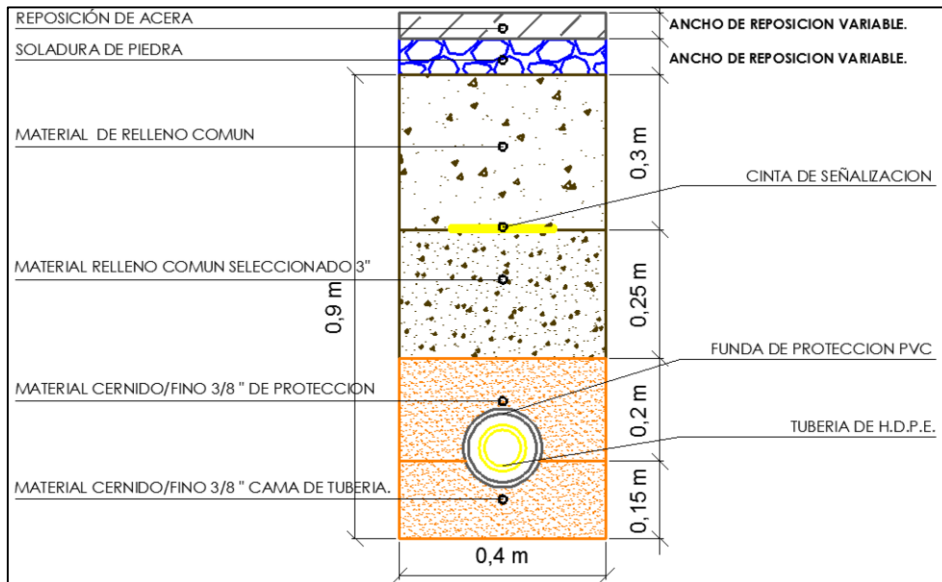

Elaborado y Revisado por:	Aprobado por:



2.2. CALCAZADAS
TERRENO BLANDO

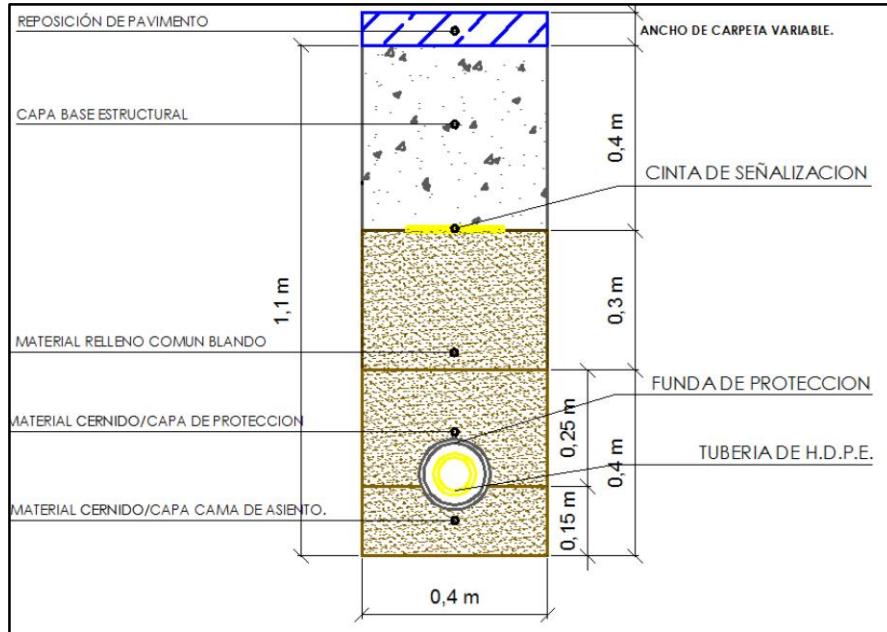

TERRENO SEMIDURO

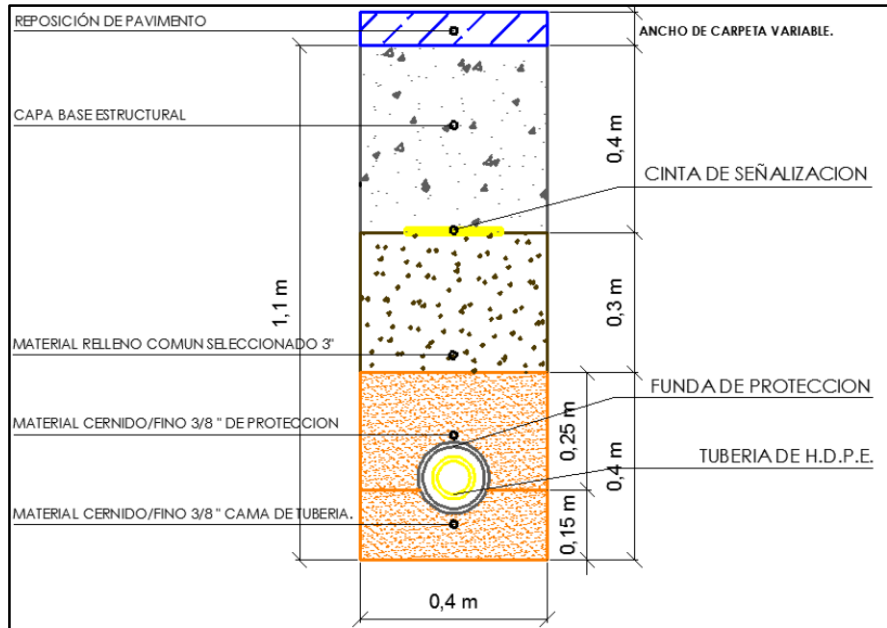

Elaborado y Revisado por:	Aprobado por:



3. OBRAS DE FIJACIÓN DE VÁLVULAS Y SEÑALIZACIÓN HORIZONTAL

3.1 BASES DE HORMIGÓN PARA SEÑALIZACIÓN HORIZONTAL EN COBERTURAS DE EMPEDRADO Y TIERRA

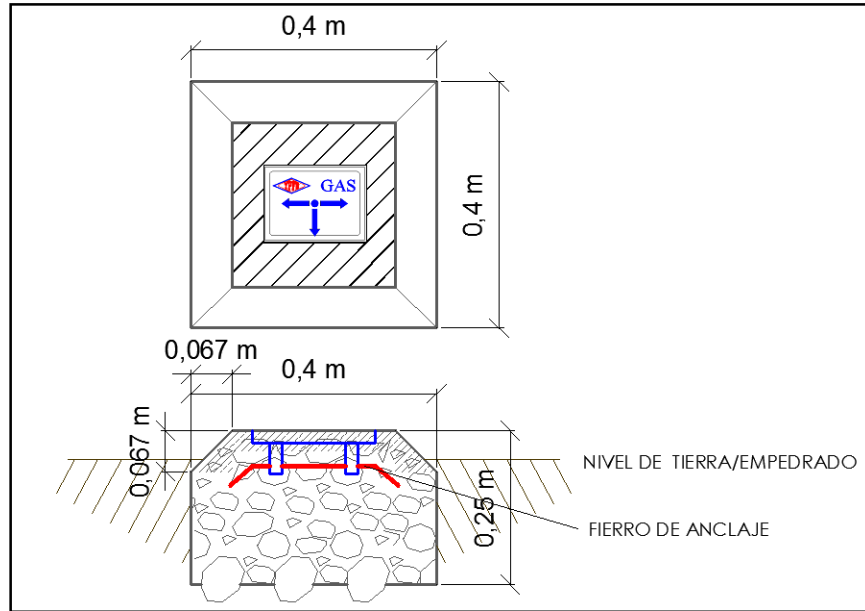

3.2 PLAQUETAS DE SEÑALIZACIÓN HORIZONTAL EN COBERTURAS DE ACERAS DE HORMIGÓN

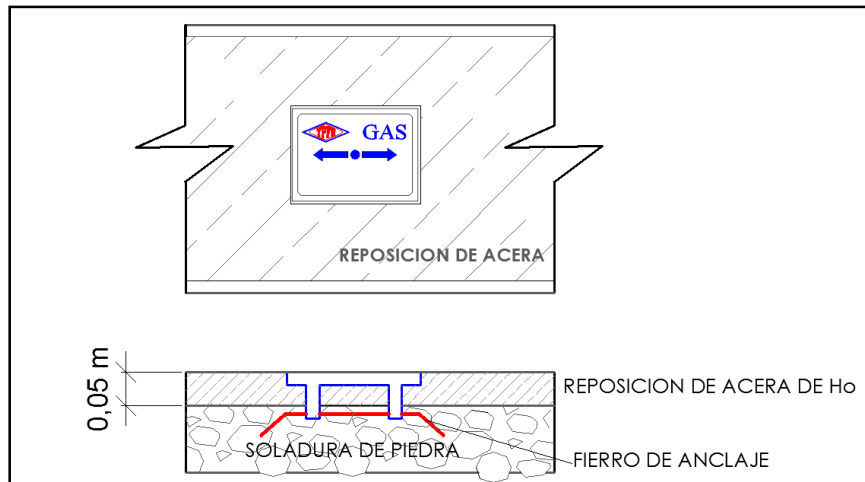

Elaborado y Revisado por:	Aprobado por:

3.3 ESTRUCTURA PARA VÁLVULAS

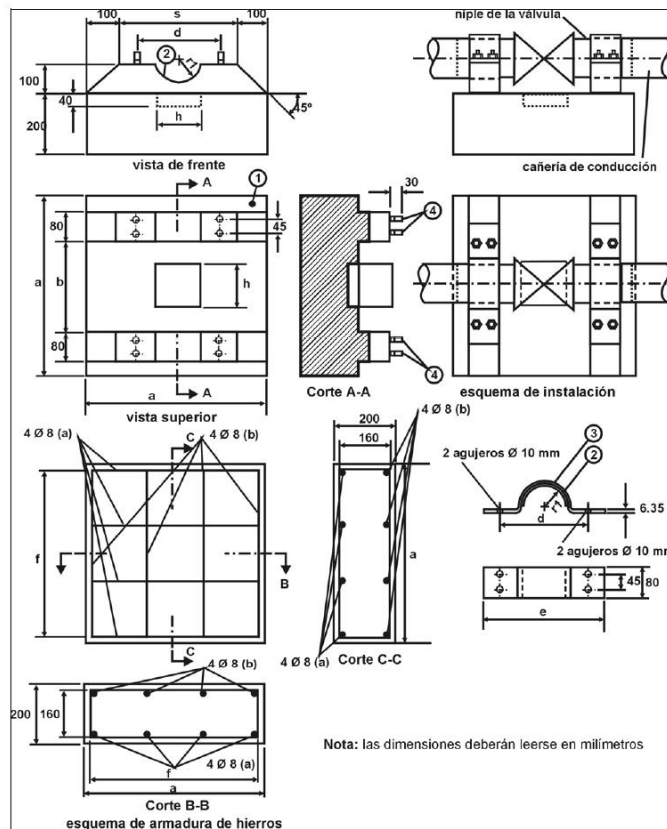
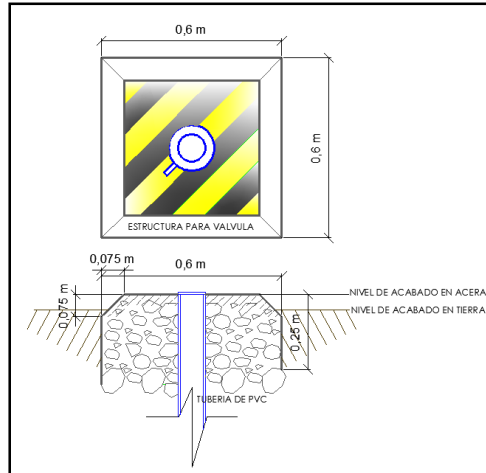

Elaborado y Revisado por:	Aprobado por:

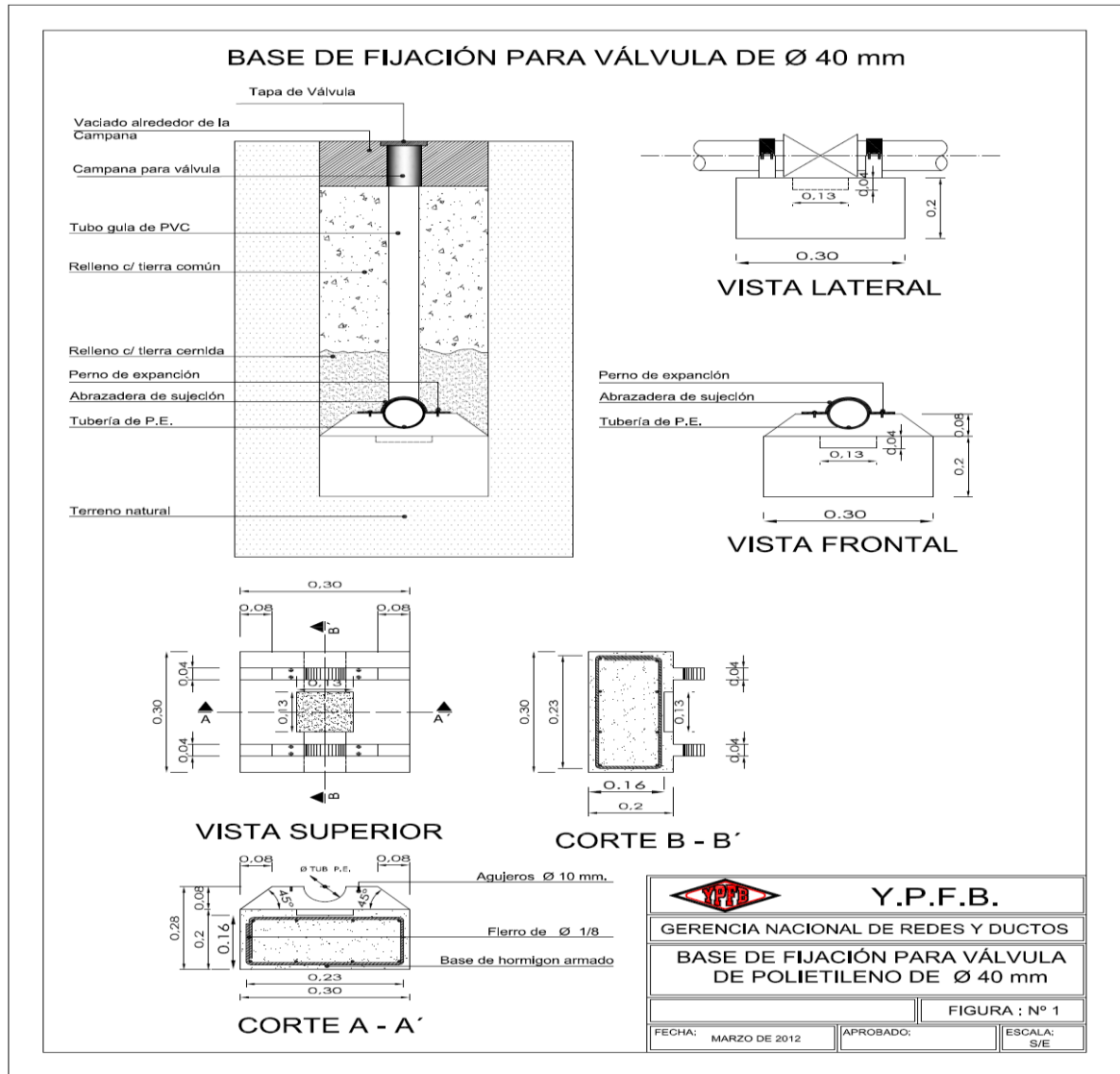

Elaborado y Revisado por:	Aprobado por:

BASE DE FIJACIÓN PARA VÁLVULA DE POLIETILENO

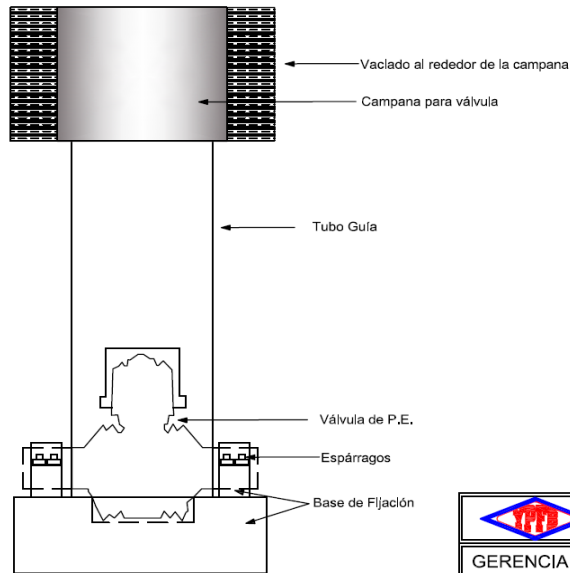
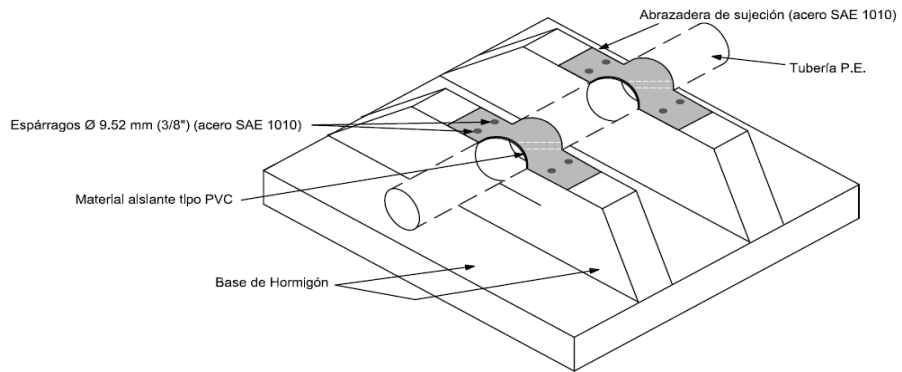

VISTA - CORTE PARA VACIADO ALREDEDOR DE CAMPANA

	Y.P.F.B.
GERENCIA NACIONAL DE REDES Y DUCTOS	
ESQUEMA DE FIJACIÓN PARA VÁLVULA DE POLIETILENO	
FIGURA : N° 2	
FECHA: FEBRERO DE 2011	APROBADO:
	ESCALA: S/E

Elaborado y Revisado por:	Aprobado por:



3.4 DETALLE DE LA BASE DE FIJACIÓN DE VÁLVULA DE P.E

Pos.	Denominación	Cantidad
1	Base de hormigón	
2	Material asilante tipo P.V.C.	
3	Abrazadera de sujeción (acero SAE 1010)	2
4	Espárragos \varnothing 9,52 mm (3/8") (acero SAE 1010)	8

Dimensión \varnothing válvula mm.	a	b	c	d	e	f	r	h
mm.	mm.		mm.	mm.	mm.	mm.	mm.	mm.
40	267	Esta dimensión será tal que la sujeción se realice sobre el niple de la válvula o la transición de acero	133	67	93	240	23	123
63	420		210	105	147	378	37	185
90	700		500	140	180	660	47	185
110	700		500	160	200	660	60	211
125	795		568	182	227	750	68	240

4. TRANSPORTE Y MANIPULACIÓN DE TUBERÍA

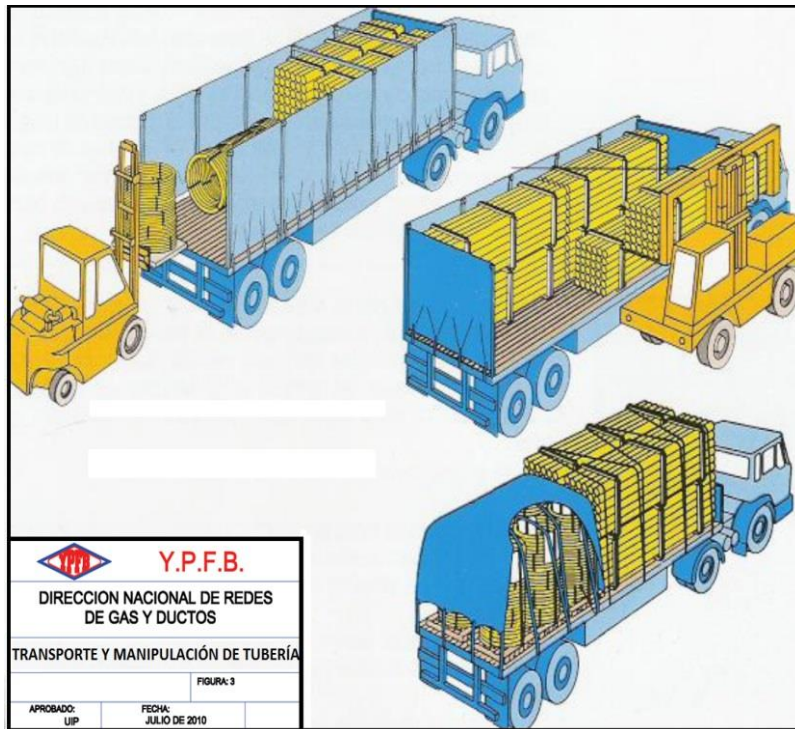

Elaborado y Revisado por:	Aprobado por:



La fuerza que transforma Bolivia

4.1 TRANSPORTE DE TUBERÍA

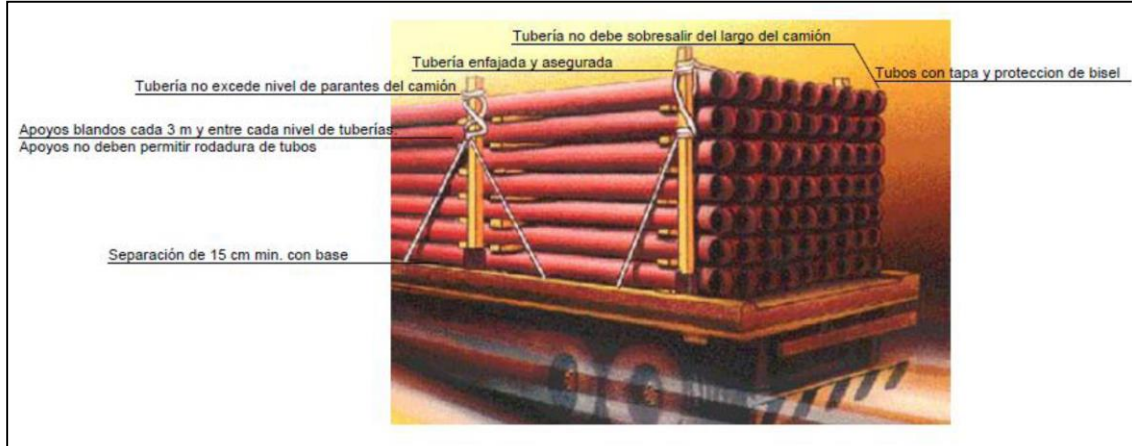

4.2 ALMACENAJE DE TUBERÍA



Elaborado y Revisado por:	Aprobado por:



5. REPOSICIONES EN ACERA Y CALZADA

5.1 ACERAS DE HORMIGÓN.

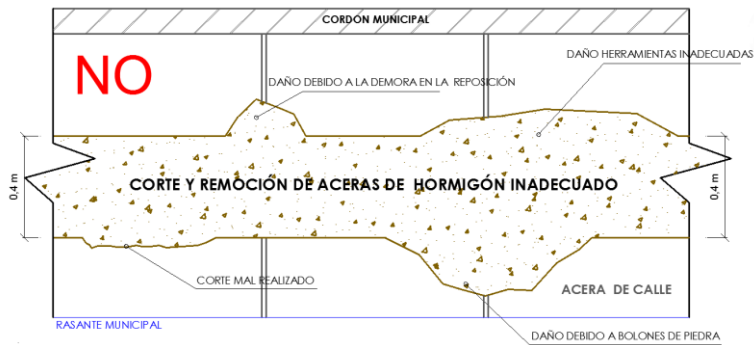
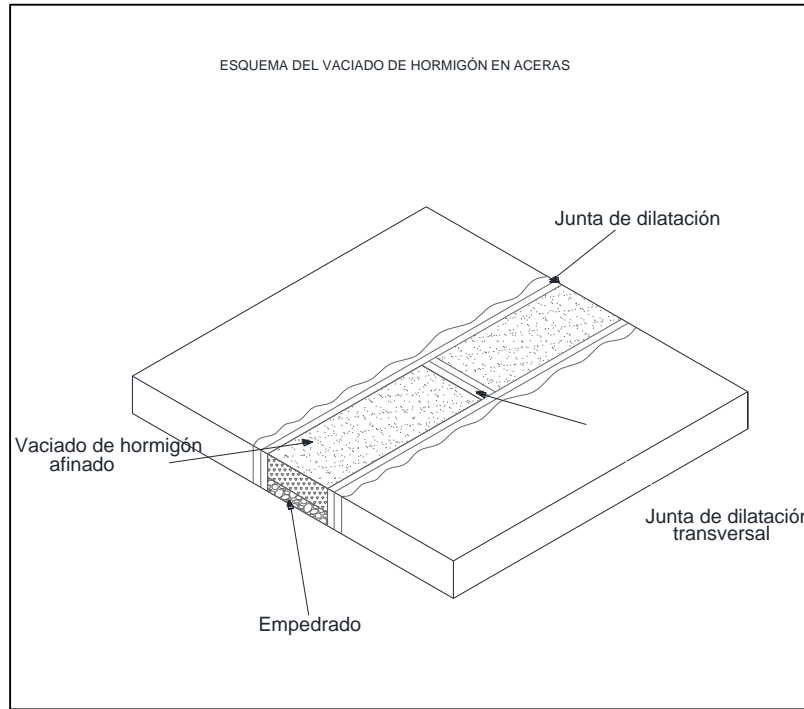

Elaborado y Revisado por:	Aprobado por:

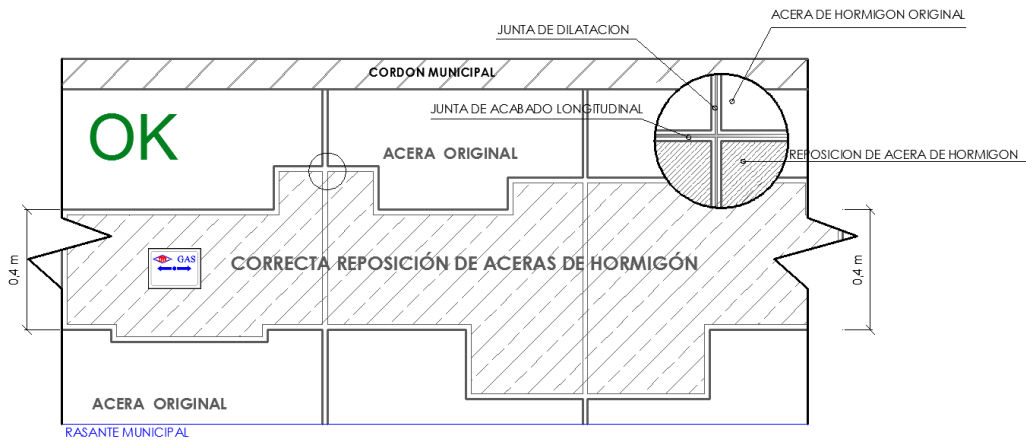

5.2 REPOSICIONES DE PAVIMENTOS (FLEXIBLES Y RÍGIDOS).

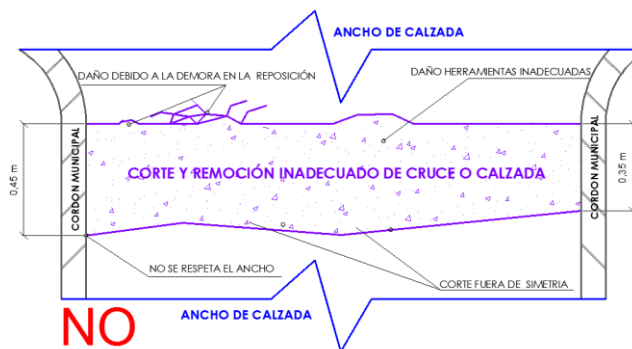

Elaborado y Revisado por:	Aprobado por:



La fuerza que transforma Bolivia

YACIMIENTOS PETROLÍFEROS FISCALES BOLIVIANOS
GERENCIA DE REDES DE GAS Y DUCTOS
DISTRITO REDES DE GAS ORURO

Anexo 2

Hoja:
13 de 15

GRAFICOS

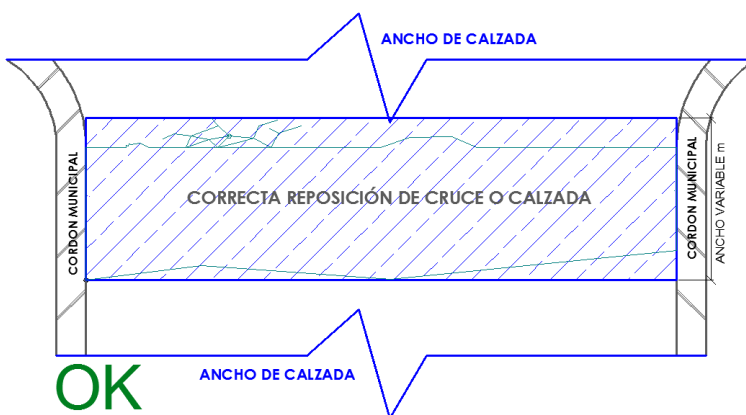
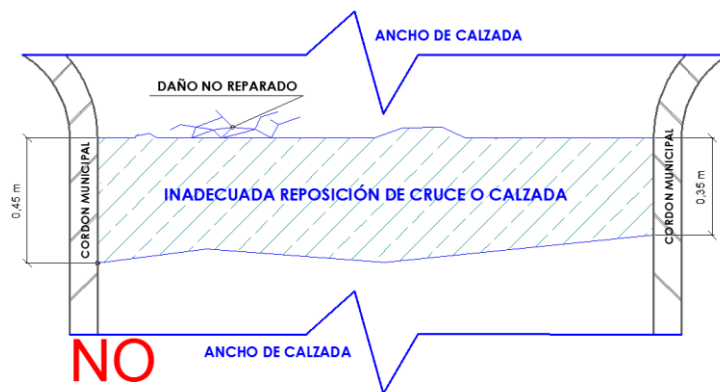

Elaborado y Revisado por:	Aprobado por:



La fuerza que transforma Bolivia

YACIMIENTOS PETROLÍFEROS FISCALES BOLIVIANOS
GERENCIA DE REDES DE GAS Y DUCTOS
DISTRITO REDES DE GAS URUO

Anexo 2

Hoja:
14 de 15

GRAFICOS

6. ADOSADO – ANCLAJE DE TUBERIA

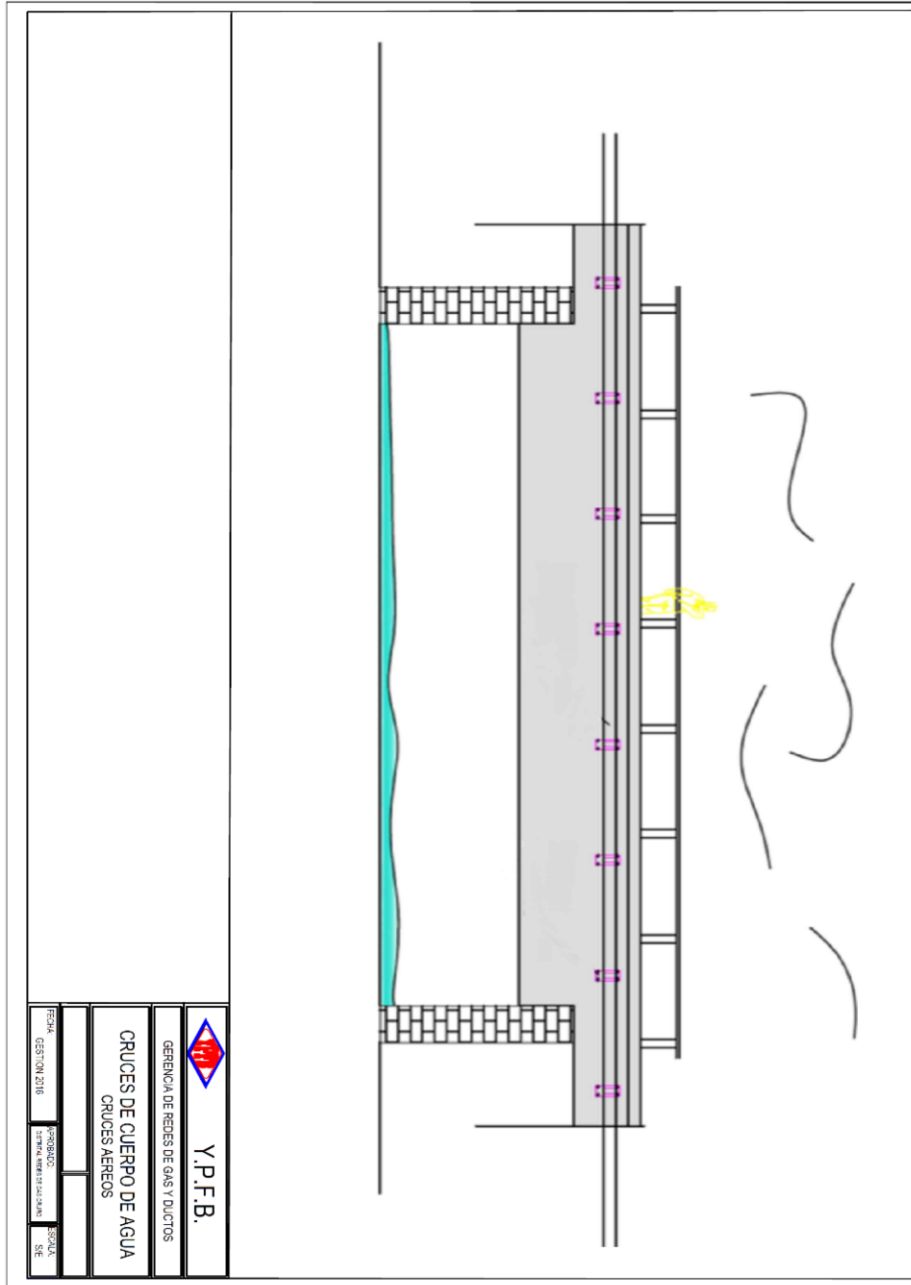

Elaborado y Revisado por:	Aprobado por:



ANCLAJES - ADOSADO DE PUENTE

VISTA FRONTAL

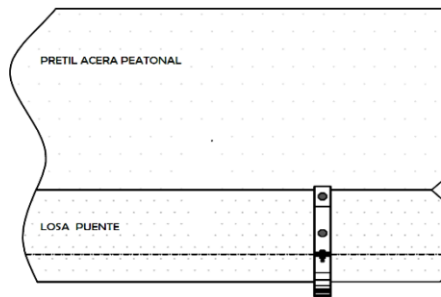

VISTA LATERAL

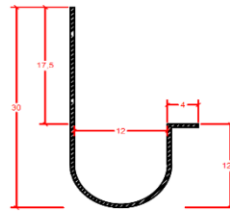
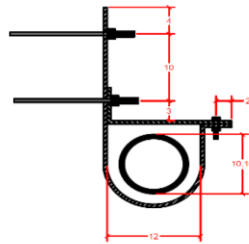
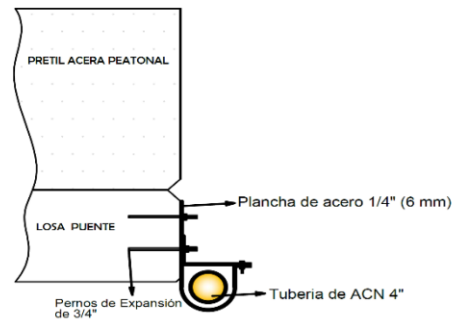

L = 21,00 [cm]

L = 51,90 [cm]

		Y.P.F.B.	
GERENCIA DE REDES DE GAS Y DUCTOS			
CRUCES DE CUERPO DE AGUA CRUCES AEREOS			
PROYECTADO:	APROBADO:	ESCALA:	
GESTION 2016	INSTRUMENTADO	S/E	

Elaborado y Revisado por:	Aprobado por: