

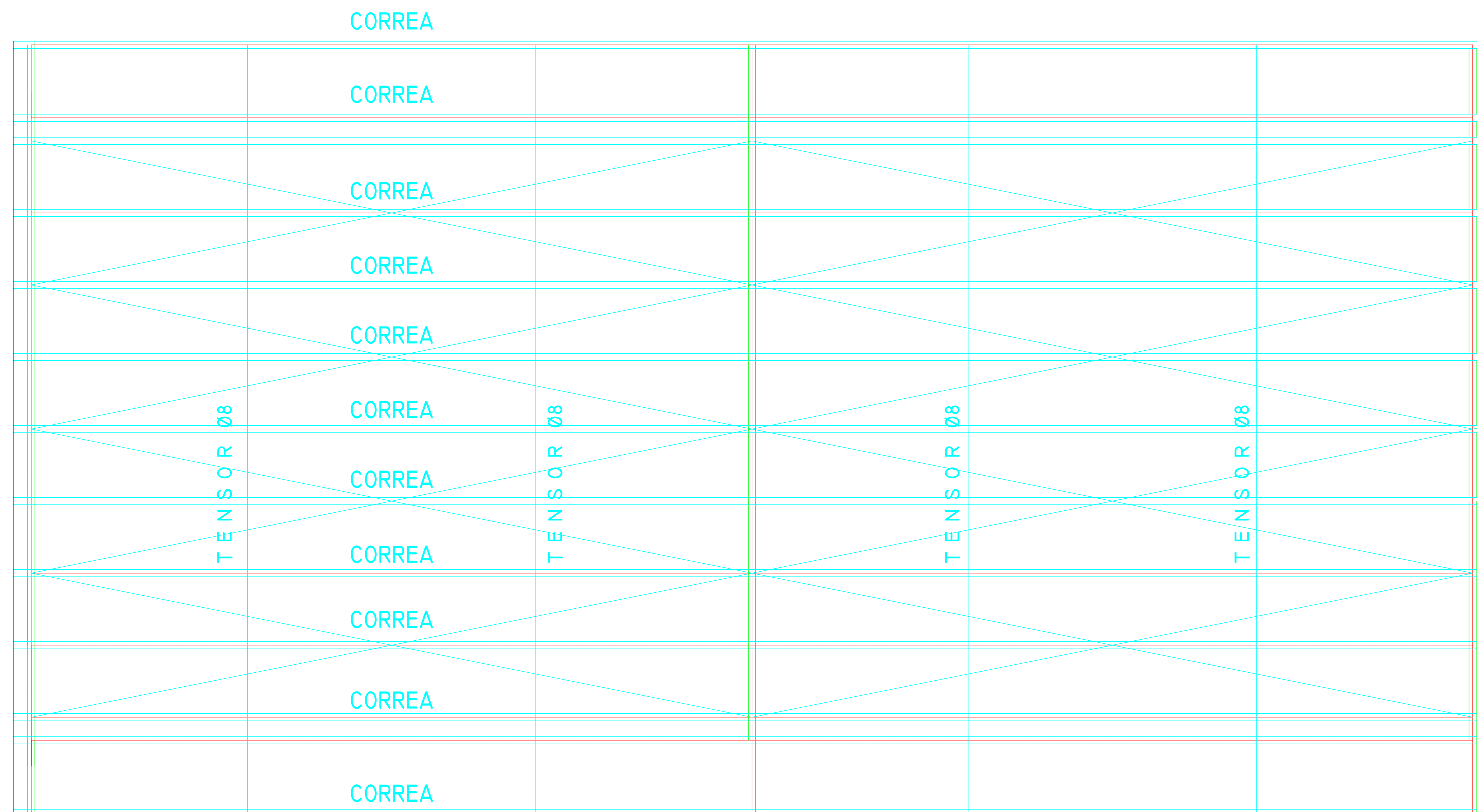

PLANO DE DETALLE ESTRUCTURA METALICA

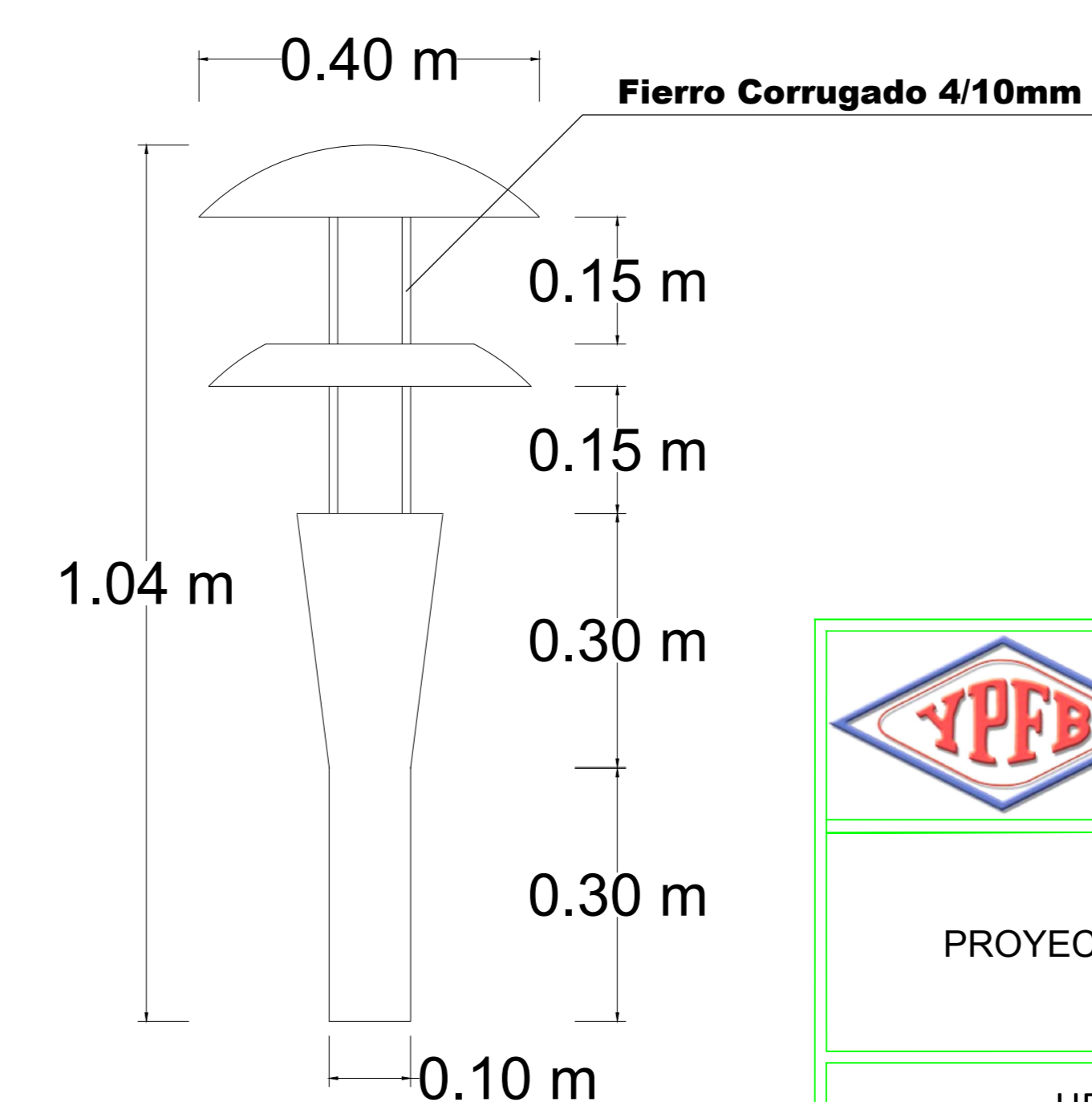
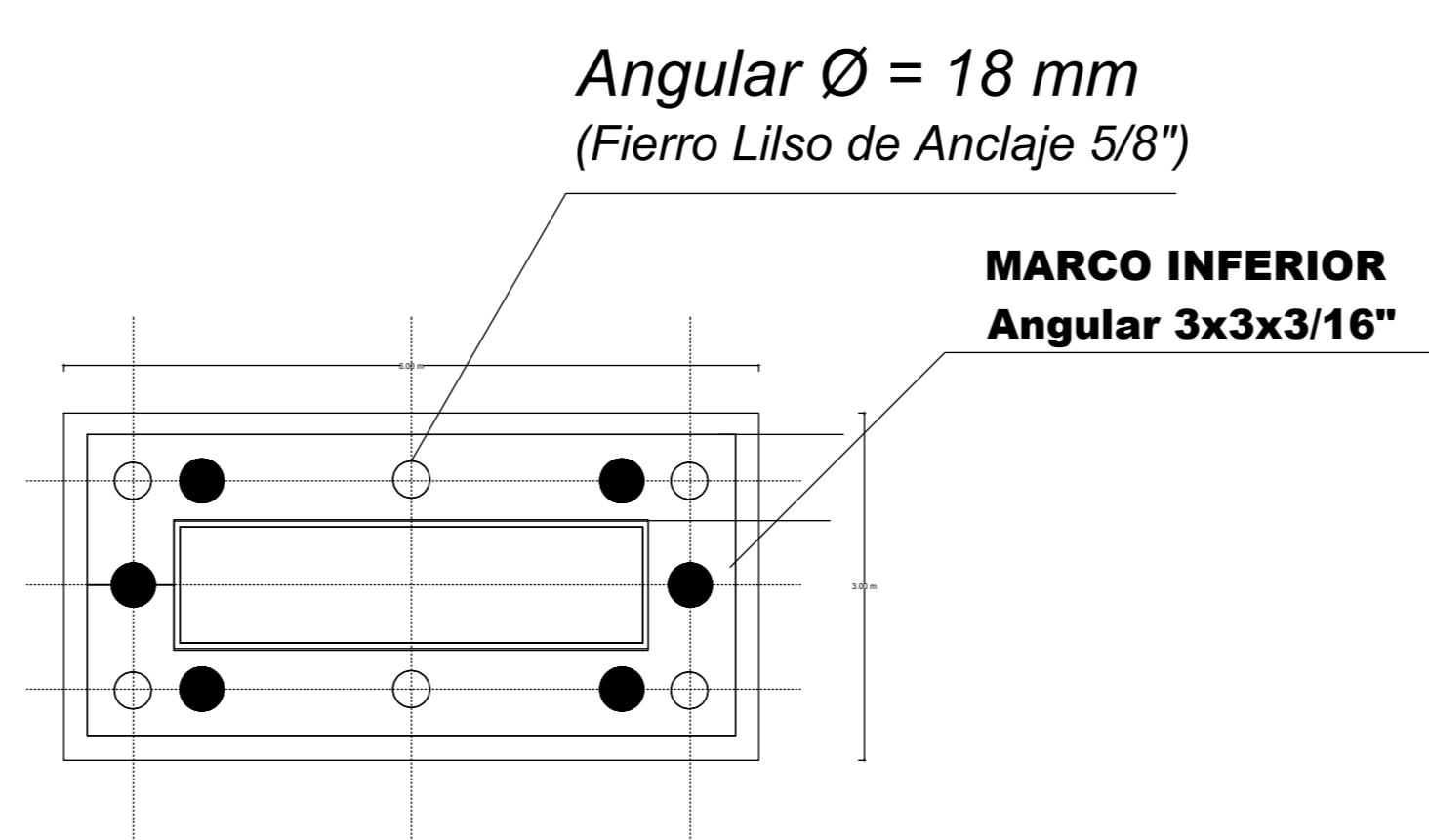
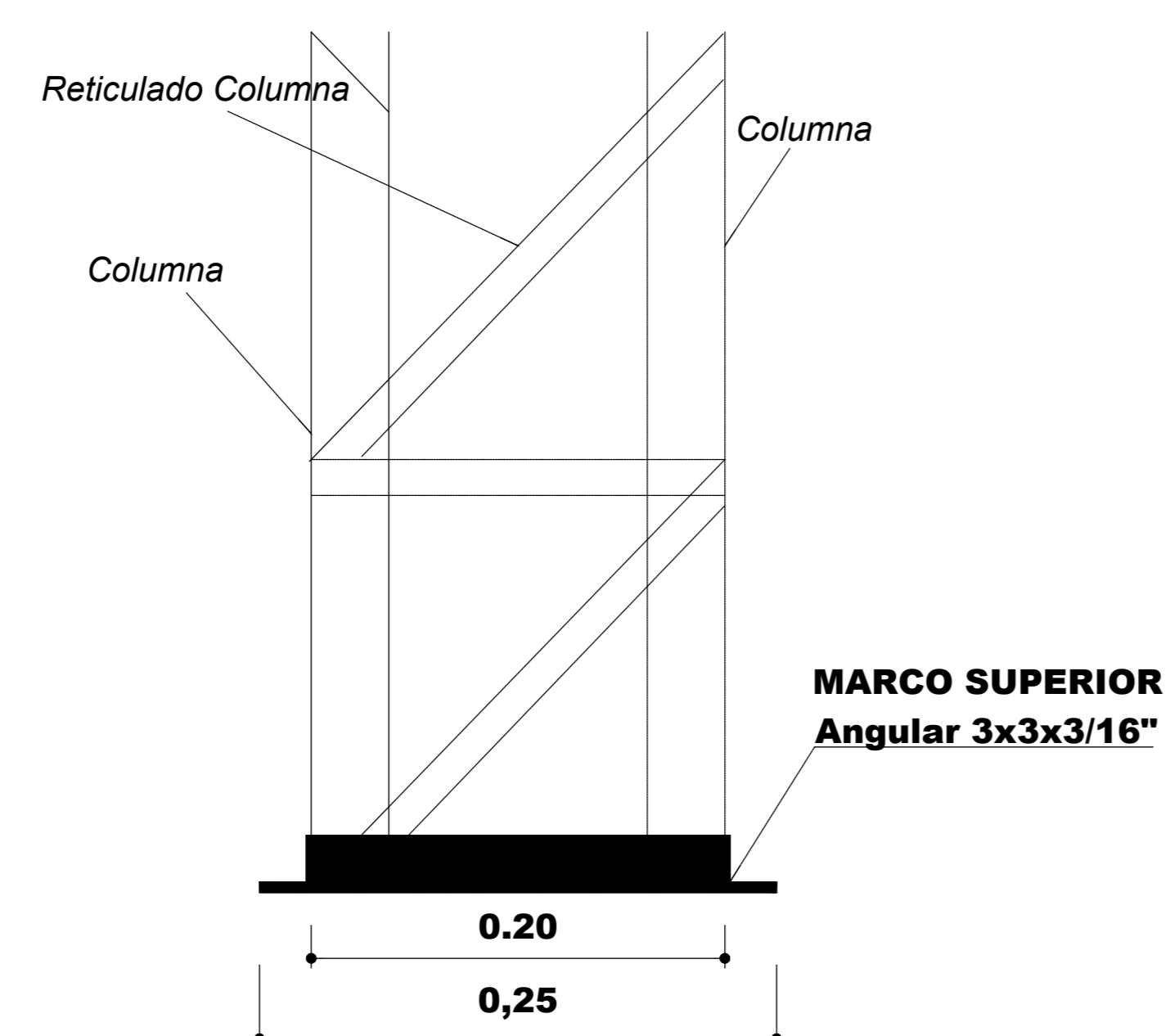
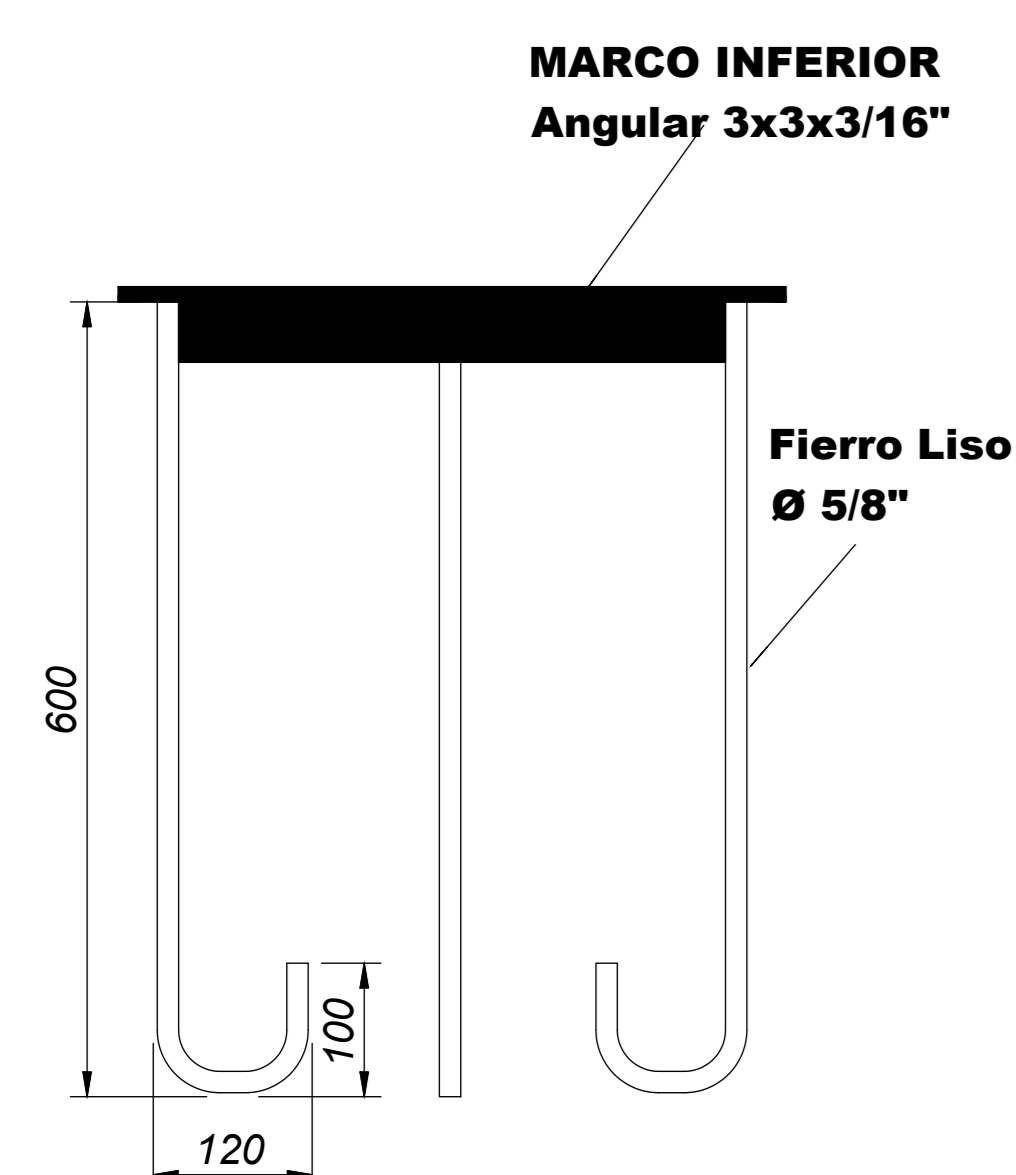

DETALLE DE CORREAS Y TENSORES

<i>TENSORES INTERIORES</i>	<i>Perfil redondo liso Ø 08 mm</i>	<i>ASTM A36</i>
<i>CORREAS</i>	<i>Perfil Costanera 100x50x15x2 mm</i>	<i>ASTM A36</i>



	YACIMIENTOS PETROLIFEROS FISCALES BOLIVIANOS	
	DISTRITAL DE REDES DE GAS COCHABAMBA	
PROYECTO:	OBRAS CIVILES, MECANICAS Y ELECTRICAS PARA EL MONTAJE Y RESGUARDO DE UN EMO EN LA POBLACIÓN DE VALLE SACTA	
UBICACIÓN: MUNICIPIO PUERTO VILLARROEL, POBLACION VALLE SACTA		
FECHA:	SEPTIEMBRE DEL 2018	LAMINA: 6/7