

# PLANOS ESTRUCTURALES - COLUMNAS Y CUBIERTA

## CASETAS DE SUSTANCIAS PELIGROSAS Y RESIDUOS SOLIDOS

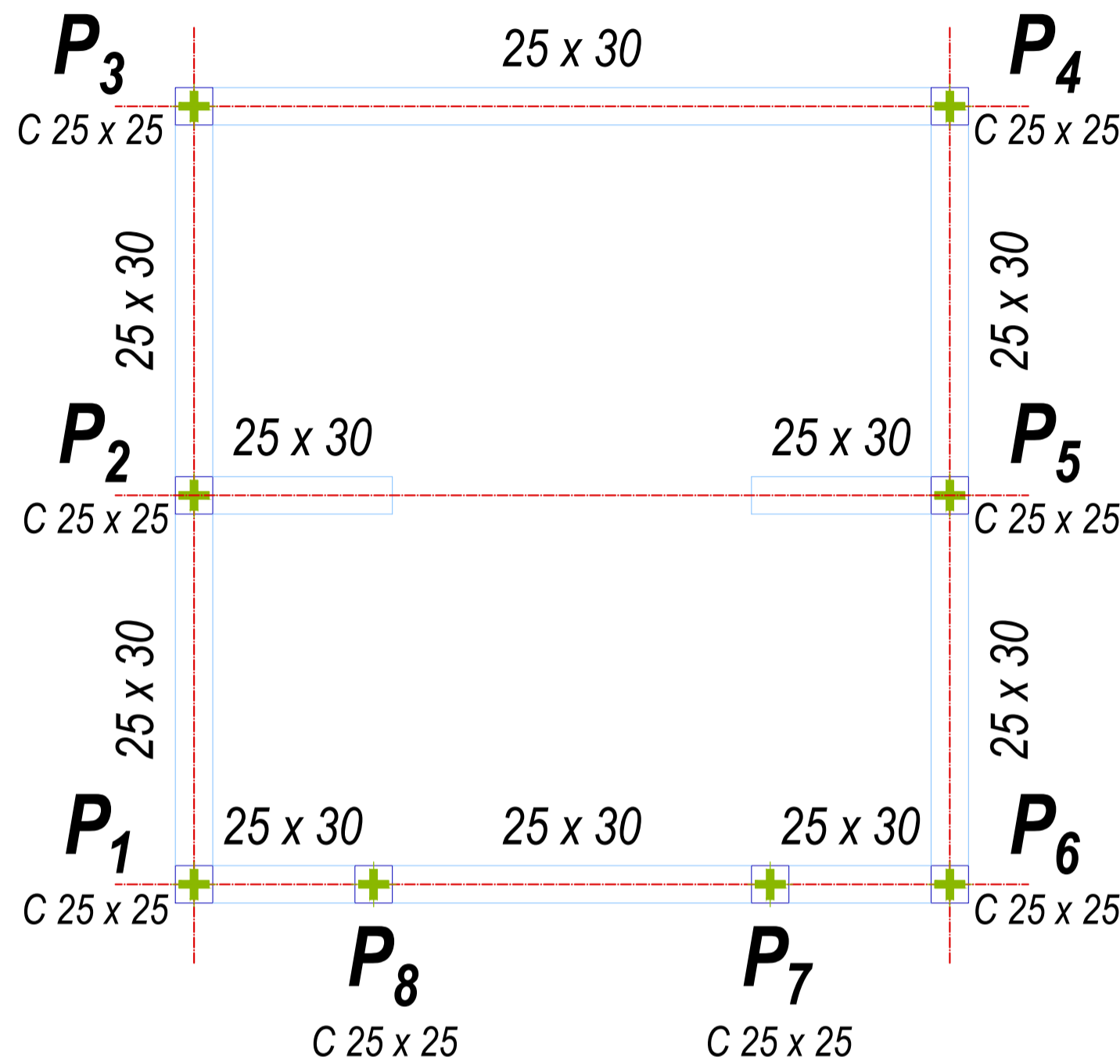

### COLUMNAS NIVEL DEL TERRENO

$$P_1 = P_2 = P_3 = P_4 = P_5 = P_6 = P_7 = P_8$$

DIAMETRO (mm)	CANTIDAD	LONG. PARCIAL	LONG. TOTAL	LONG. x 8 PZA
Ø 12	4	200	800	6400
Ø 12	4	87	348	2784
Ø 6	13	96	1248	9984

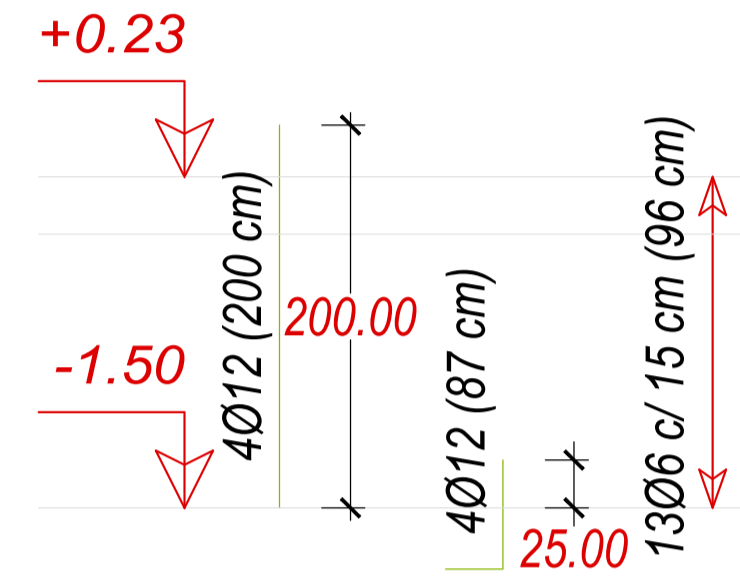
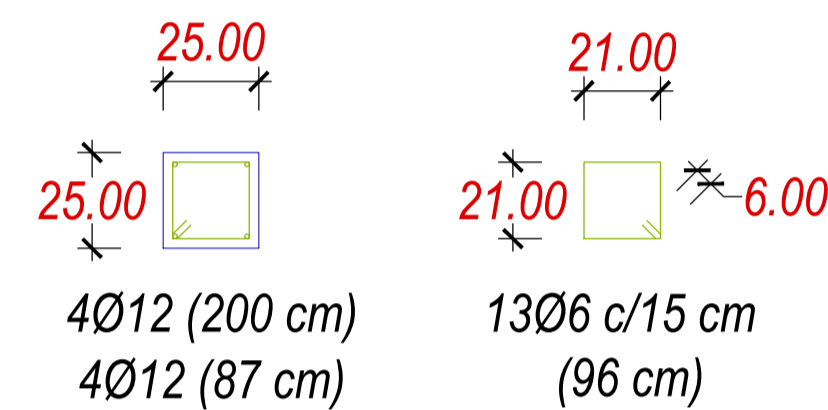

RESUMEN DE ACERO - COLUMNAS						
REFERENCIAS	DIAMETRO (mm)	CANTIDAD	LONG. PARCIAL (cm)	LONG. TOTAL (cm)	PESO (Kg)	
P <sub>1</sub> -P <sub>2</sub> -P <sub>3</sub> -P <sub>4</sub> -P <sub>5</sub> -P <sub>6</sub> -P <sub>7</sub> -P <sub>8</sub>	Ø 12	4	200	800	7.10	
	Ø 12	4	87	348	3.10	
	Ø 6	13	96	1248	2.80	
COLUMNAS NIVEL DEL TERRENO					<b>PESO TOTAL + 10% (x 8 pza)</b>	<b>114.40</b>
P <sub>1</sub> -P <sub>2</sub> -P <sub>3</sub> -P <sub>4</sub> -P <sub>5</sub> -P <sub>6</sub> -P <sub>7</sub> -P <sub>8</sub>	Ø 12	4	340	1360	12.10	
	Ø 6	23	96	2208	4.90	
COLUMNAS NIVEL DE LA CUBIERTA					<b>PESO TOTAL + 10% (x 8 pza)</b>	<b>149.60</b>
	Ø 6				67.76	
	Ø 12				196.24	
					<b>PESO TOTAL (Kg)</b>	<b>264.00</b>

### COLUMNAS NIVEL DE LA CUBIERTA

$$P_1 = P_2 = P_3 = P_4 = P_5 = P_6 = P_7 = P_8$$

DIAMETRO (mm)	CANTIDAD	LONG. PARCIAL	LONG. TOTAL	LONG. x 8 PZA
Ø 12	4	340	1360	10880
Ø 6	23	96	2208	17664

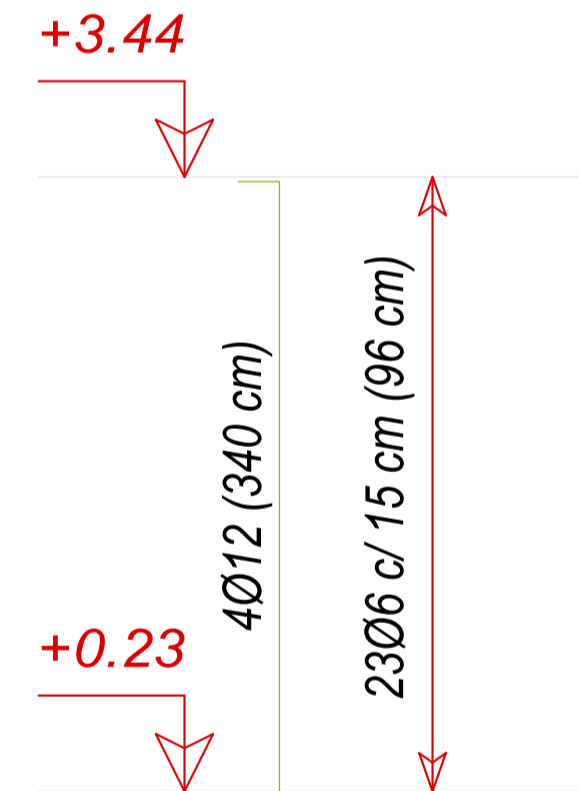
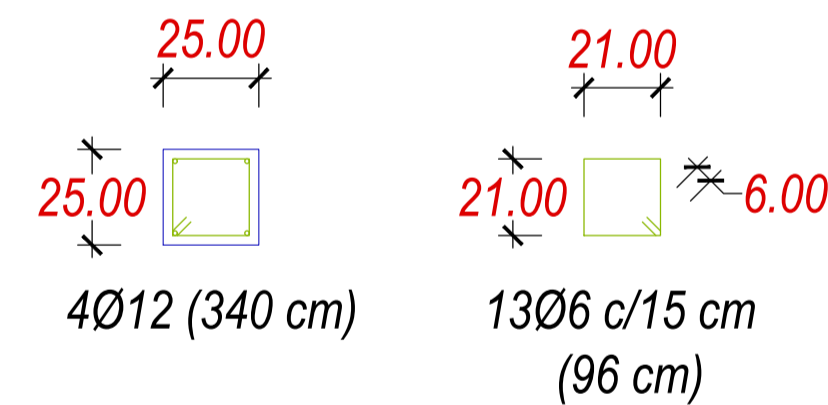

### ESTRUCTURA METALICA

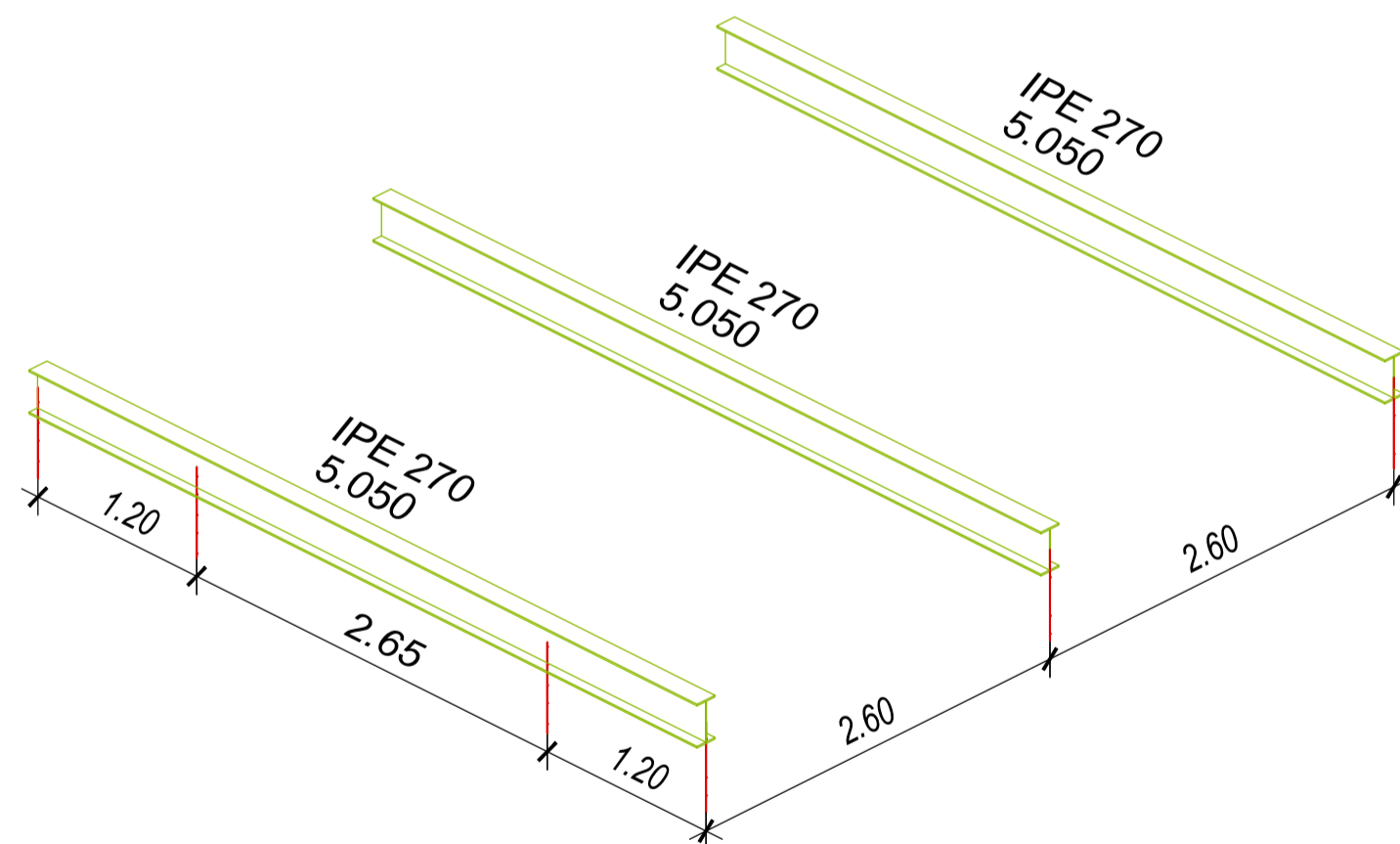

### DETALLE DE LOS PERFILES Y CORREAS

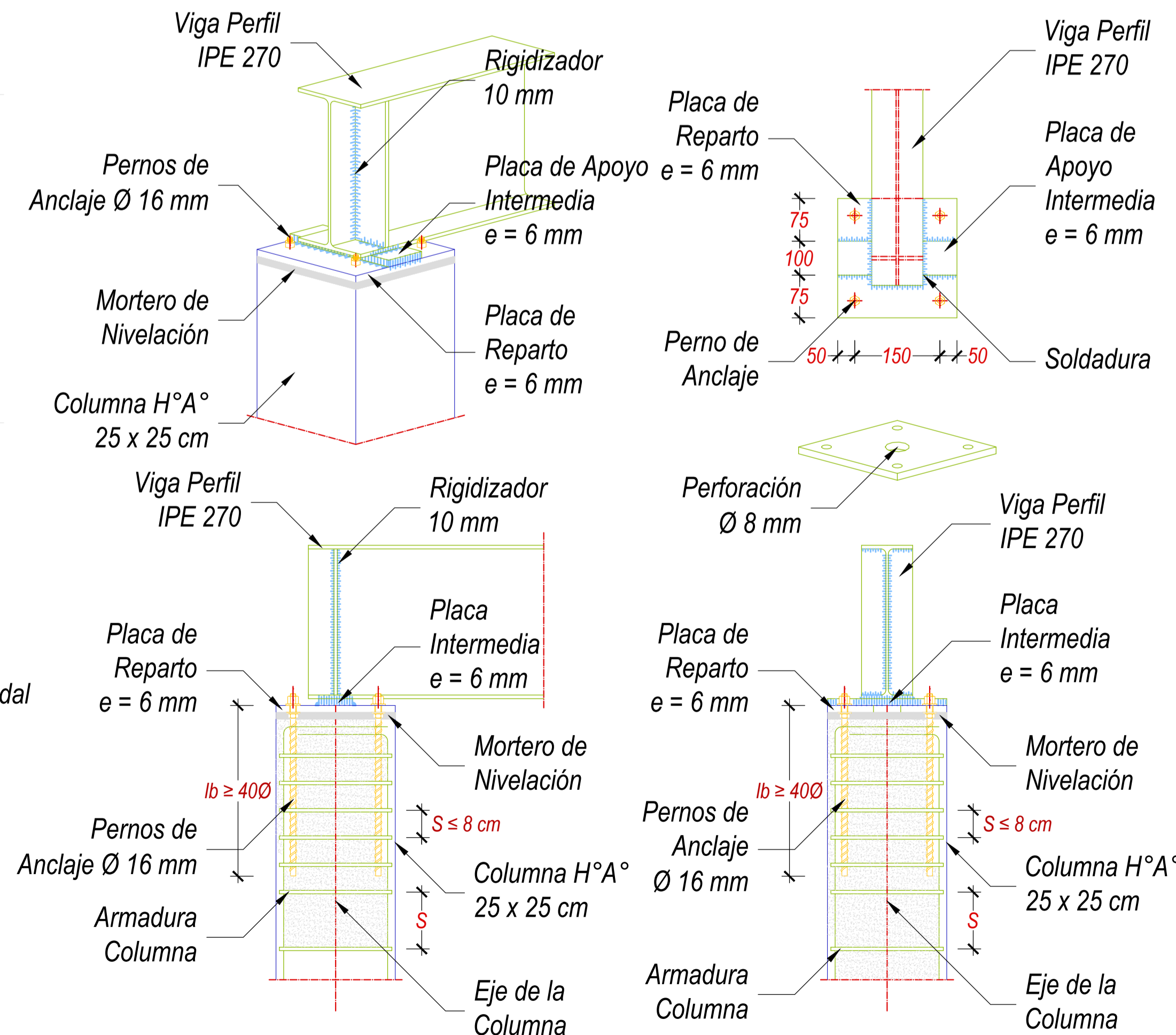
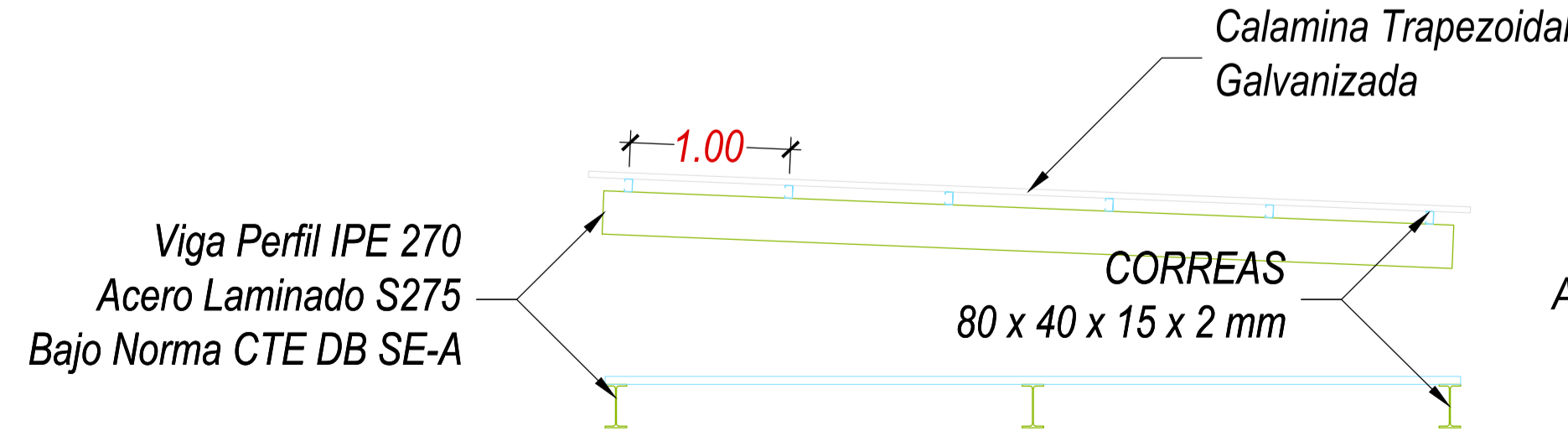
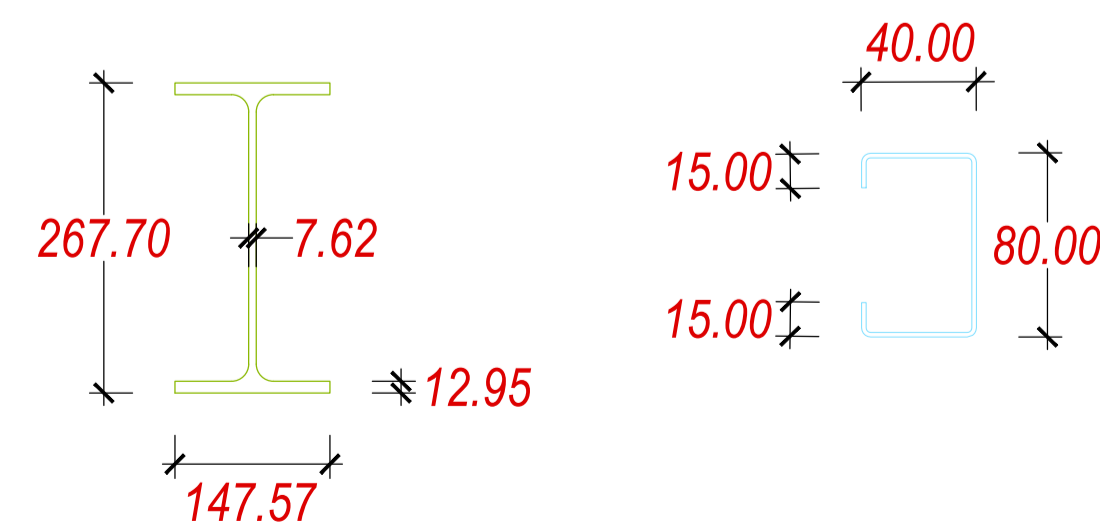

INFORMACION GENERAL

Y.P.F.B.

PROYECTO DE OBRAS DE RECONSTRUCCION DE LA ZONA DE LA SIERRA

CONSTRUCCION DE AMBIENTES DE MANEJO DE RESIDUOS SOLIDOS MEDIANTE EL SISTEMA DE BARRILES PELIGROSOS DEL OBRAS

PLANO ESTRUCTURAL

DETALLE DE COLUMNAS Y CUBIERTA

SANTA CRUZ DE LA SIERRA

NO.	FECHA	DESCRIPCION
1	2014	PROYECTO
2	2014	REVISION
3	2014	REVISION
4	2014	REVISION
5	2014	REVISION
6	2014	REVISION
7	2014	REVISION
8	2014	REVISION
9	2014	REVISION
10	2014	REVISION

OP-DIM-LIFE-EST-CC-9-10