	<p align="center">YACIMIENTOS PETROLIFEROS FISCALES BOLIVIANOS GERENCIA DE REDES DE GAS Y DUCTOS DISTRITO DE REDES DE GAS URURO</p>	<p align="right">Anexo 2</p>
	<p align="center">GRAFICOS</p>	<p>Hoja: 1 de 12</p>

## GRÁFICOS

### 1. LETREROS

#### 1.1. LETREROS DE SEÑALIZACIÓN - HOMBRES TRABAJANDO.

(ESTRUCTURA METÁLICA, 850 mm de ancho por 1300 mm de alto)



Elaborado por:	Revisado por:	Aprobado por :



## 2. EXCAVACIÓN DE ZANJAS

### 2.1. ACERAS TERRENO BLANDO

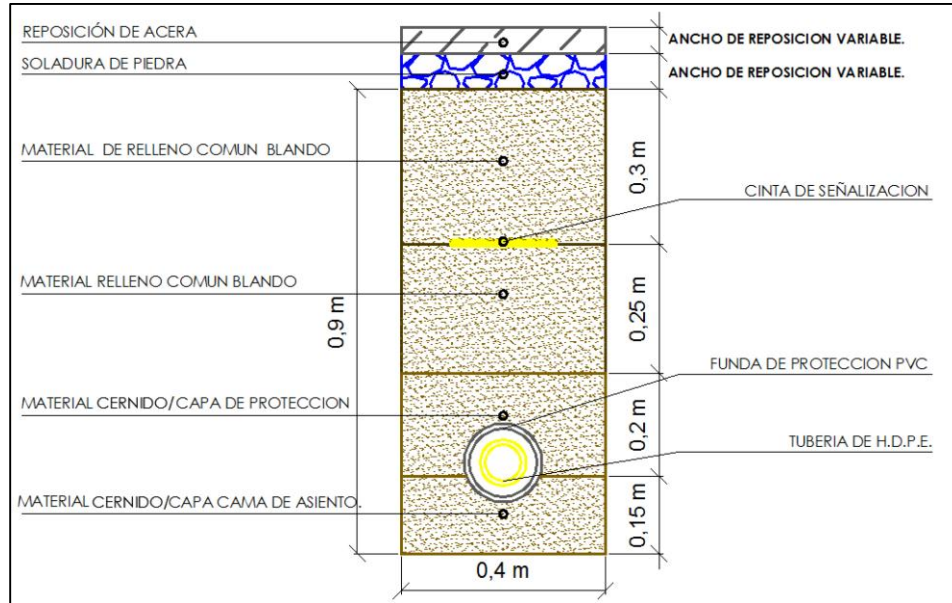

### TERRENO SEMIDURO

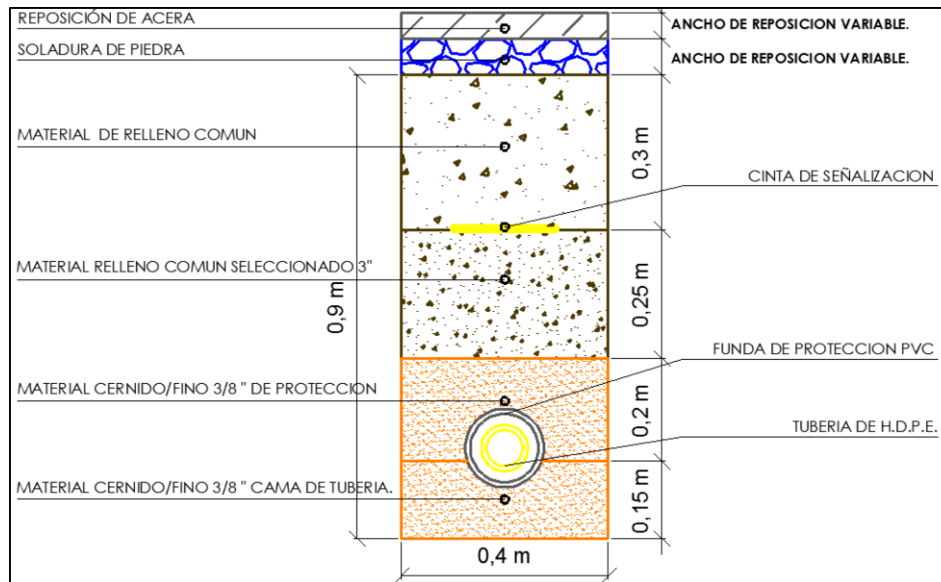

Elaborado por:	Revisado por:	Aprobado por :



TERRENOS DUROS Y ROCOSOS

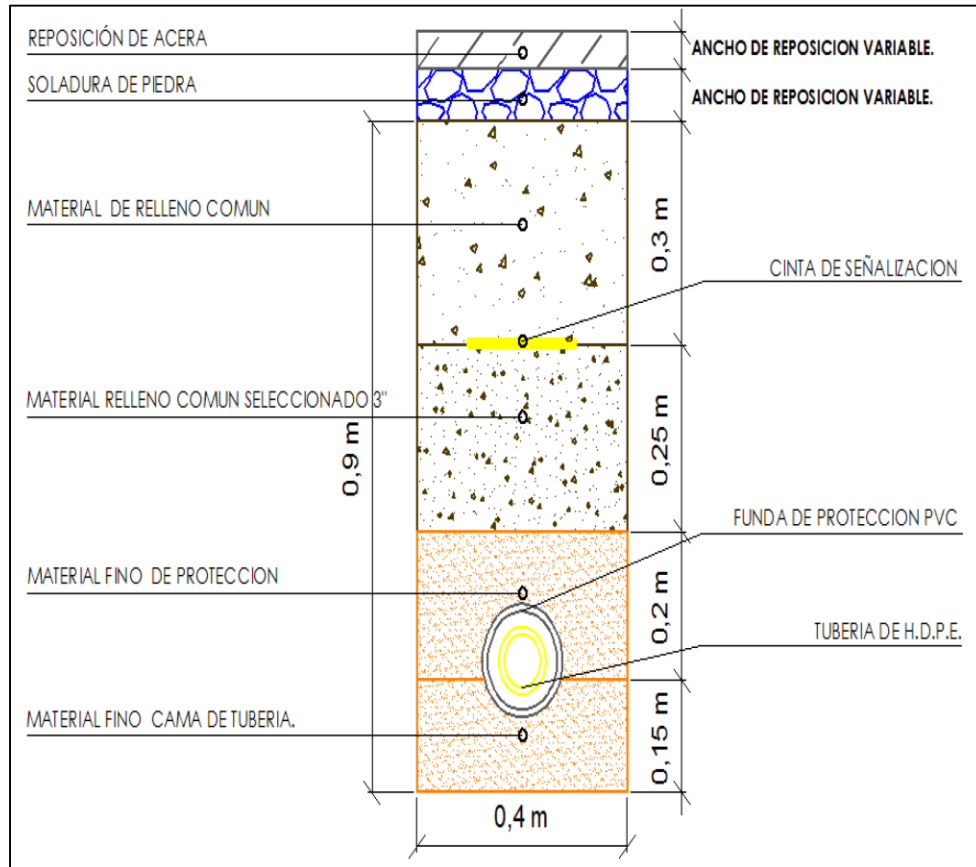

Elaborado por:	Revisado por:	Aprobado por :

	<b>YACIMIENTOS PETROLIFEROS FISCALES BOLIVIANOS</b> <b>GERENCIA DE REDES DE GAS Y DUCTOS</b> <b>DISTRITO DE REDES DE GAS URUO</b>	Anexo 2
	<b>GRAFICOS</b>	Hoja: 4 de 12

2.2. CALZADAS  
 TERRENO BLANDO

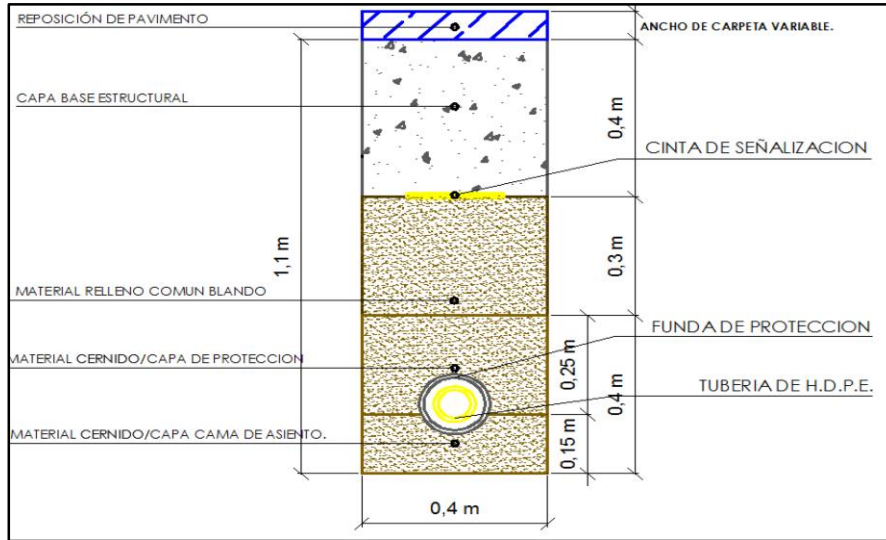

3. OBRAS DE FIJACIÓN DE VÁLVULAS Y SEÑALIZACIÓN HORIZONTAL

3.1. BASES DE HORMIGÓN PARA SEÑALIZACIÓN HORIZONTAL EN COBERTURAS DE EMPEDRADO Y TIERRA

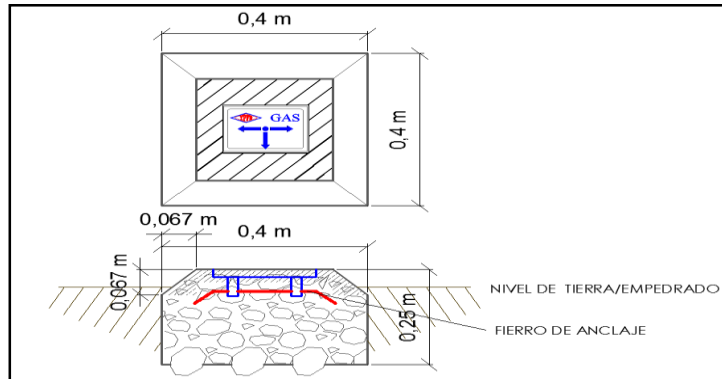

Elaborado por:	Revisado por:	Aprobado por :

	<b>YACIMIENTOS PETROLIFEROS FISCALES BOLIVIANOS</b> <b>GERENCIA DE REDES DE GAS Y DUCTOS</b> <b>DISTRITO DE REDES DE GAS ORURO</b>	Anexo 2
	<b>GRAFICOS</b>	Hoja: 5 de 12

### 3.2. PLAQUETAS DE SEÑALIZACIÓN HORIZONTAL EN COBERTURAS DE ACERAS DE HORMIGÓN

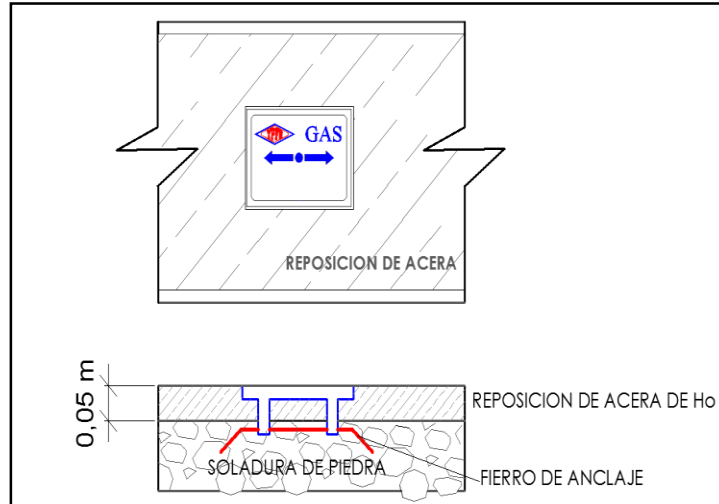

#### PLAQUETAS DE SEÑALIZACIÓN VERTICAL PARA VALVULAS DE CONTROL



Elaborado por:	Revisado por:	Aprobado por :

	<b>YACIMIENTOS PETROLIFEROS FISCALES BOLIVIANOS</b> <b>GERENCIA DE REDES DE GAS Y DUCTOS</b> <b>DISTRITO DE REDES DE GAS ORURO</b>	Anexo 2
	<b>GRAFICOS</b>	Hoja: 6 de 12

PLAQUETAS DE SEÑALIZACIÓN VERTICAL EN COBERTURAS DE HORMIGÓN



Señalización gabinetes no visibles (medidores Internos)

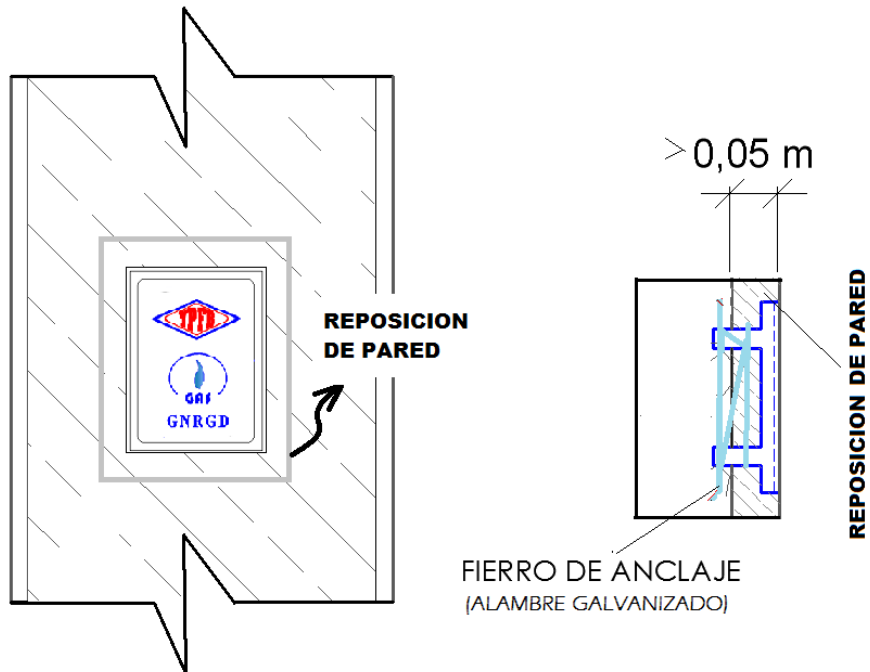

Elaborado por:	Revisado por:	Aprobado por :

	<b>YACIMIENTOS PETROLIFEROS FISCALES BOLIVIANOS</b> <b>GERENCIA DE REDES DE GAS Y DUCTOS</b> <b>DISTRITO DE REDES DE GAS ORURO</b>	<b>Anexo 2</b>
	<b>GRAFICOS</b>	<b>Hoja:</b> <b>7 de 12</b>

#### 4. OBRAS DE FIJACIÓN DE VÁLVULAS

##### 4.1. ESTRUCTURA PARA VÁLVULAS EN ACERA

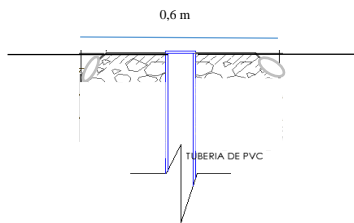

##### 4.2. ESTRUCTURA PARA VÁLVULAS SIN ACERA

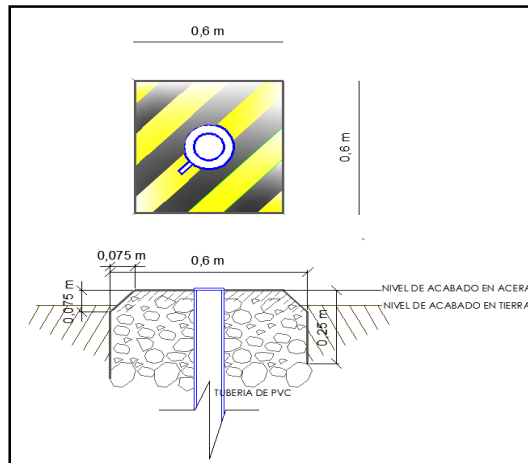

Elaborado por:	Revisado por:	Aprobado por :

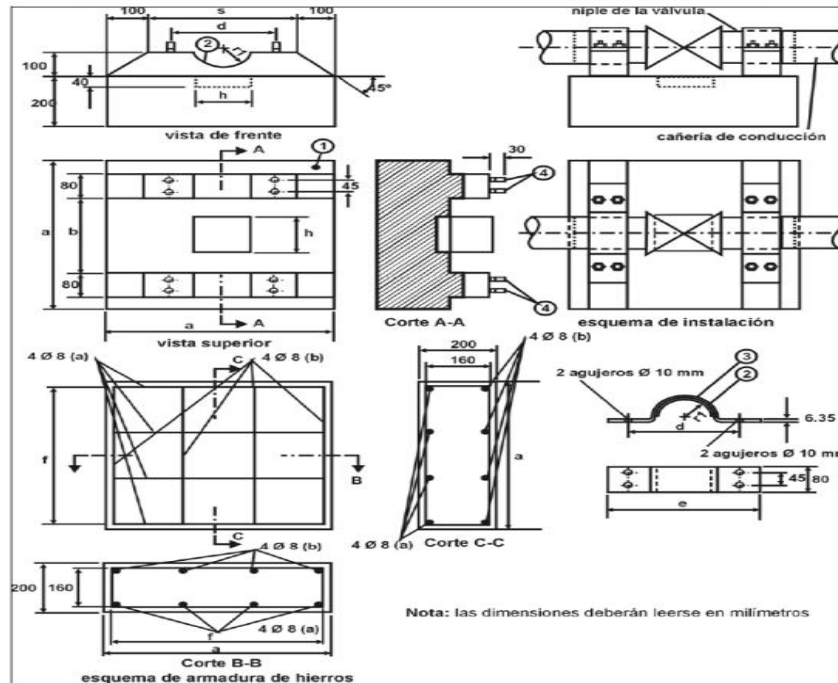
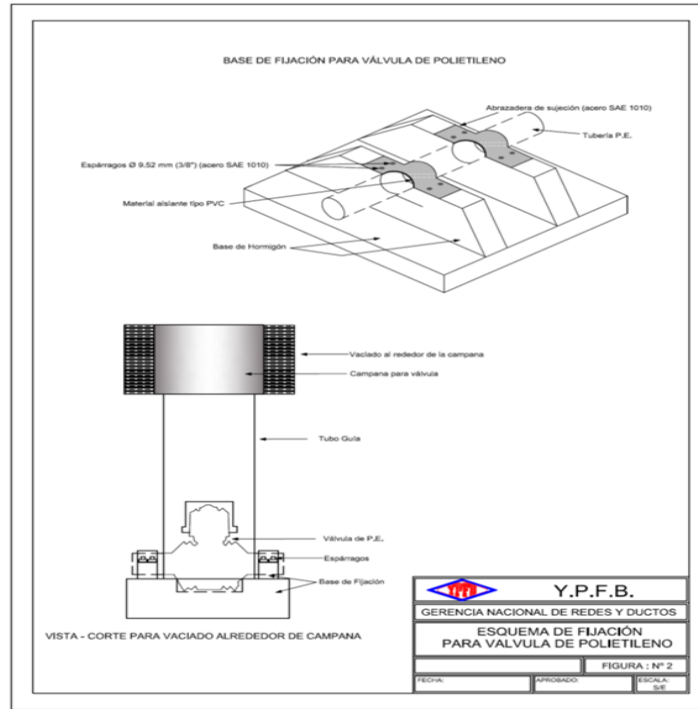

Elaborado por:	Revisado por:	Aprobado por :



### 5 DETALLE DE LA BASE DE FIJACIÓN DE VÁLVULA DE P.E

Pos.	Denominación	Cantidad
1	Base de hormigón	
2	Material asilante tipo P.V.C.	
3	Abrazadera de sujeción (acero SAE 1010)	2
4	Espárragos $\varnothing$ 9,52 mm (3/8") (acero SAE 1010)	8

Dimensión $\varnothing$ válvula mm.	a	b	c	d	e	f	r	h
mm.	mm.		mm.	mm.	mm.	mm.	mm.	mm.
40	267	Esta dimensión será tal que la sujeción se realice sobre el niple de la válvula o la transición de acero	133	67	93	240	23	123
63	420		210	105	147	378	37	185
90	700		500	140	180	660	47	185
110	700		500	160	200	660	60	211
125	795		568	182	227	750	68	240

#### 5.1 TRANSPORTE Y MANIPULACIÓN DE TUBERÍA

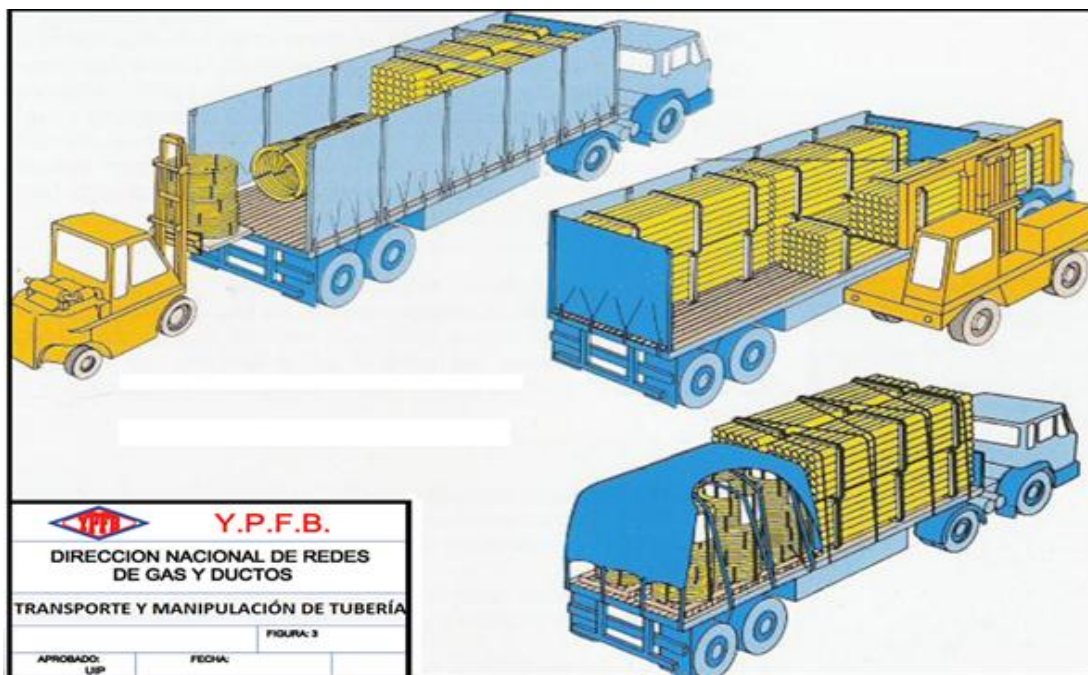

Elaborado por:	Revisado por:	Aprobado por :

	<b>YACIMIENTOS PETROLIFEROS FISCALES BOLIVIANOS</b> <b>GERENCIA DE REDES DE GAS Y DUCTOS</b> <b>DISTRITO DE REDES DE GAS ORURO</b>	Anexo 2
	<b>GRAFICOS</b>	Hoja: 10 de 12

## 5.2 TRANSPORTE DE TUBERÍA

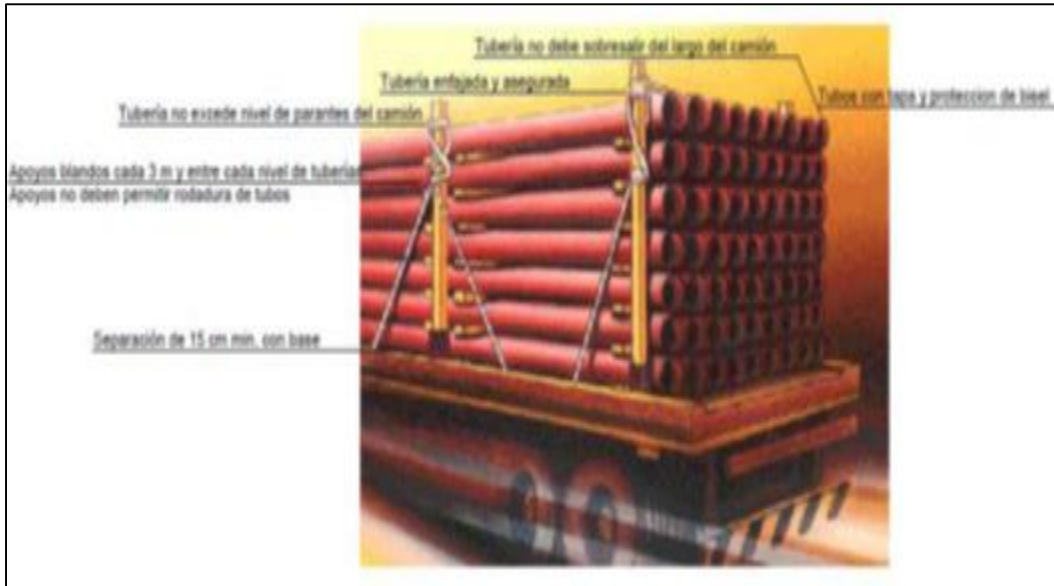

## 5.3 ALMACENAJE DE TUBERÍA



<b>Elaborado por:</b>	<b>Revisado por:</b>	<b>Aprobado por :</b>

## 6 REPOSICIONES EN ACERA

### 6.1 ACERAS DE HORMIGÓN.

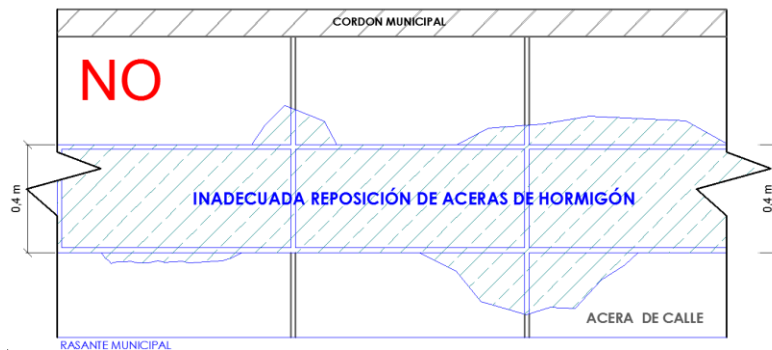
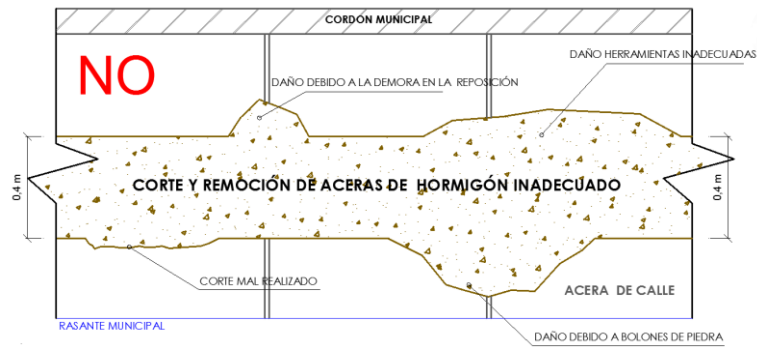
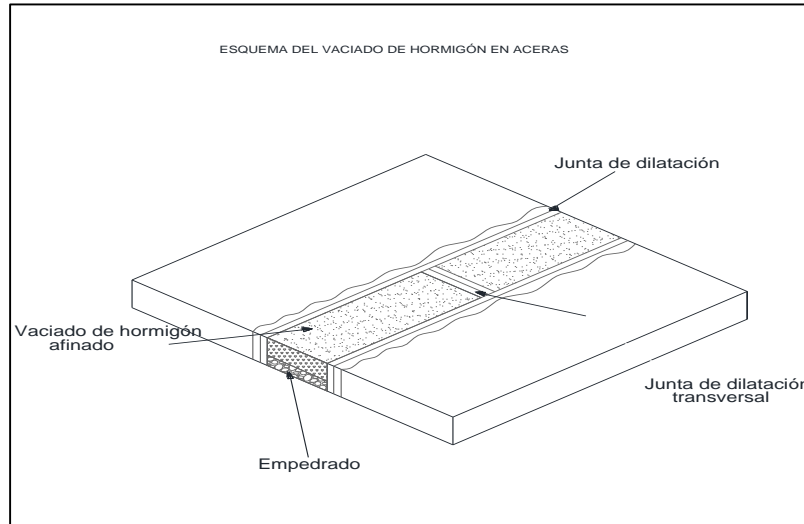

Elaborado por:	Revisado por:	Aprobado por :



**YACIMIENTOS PETROLIFEROS FISCALES BOLIVIANOS  
GERENCIA DE REDES DE GAS Y DUCTOS  
DISTRITO DE REDES DE GAS ORURO**

Anexo 2

**GRAFICOS**

Hoja:  
12 de 12

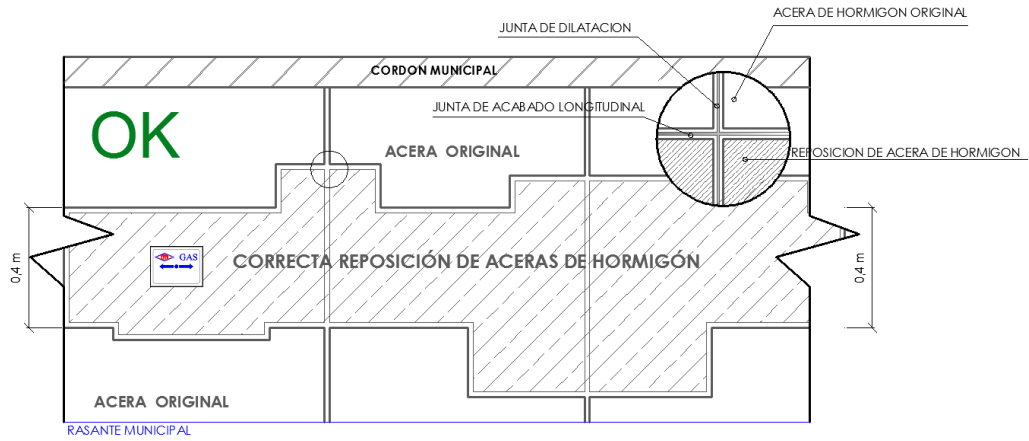

Elaborado por:	Revisado por:	Aprobado por :