	<p align="center">YACIMIENTOS PETROLIFEROS FISCALES BOLIVIANOS GERENCIA DE REDES DE GAS Y DUCTOS DISTRITO DE REDES DE GAS ORURO</p>	<p align="right">Anexo 3</p>
	<p align="center">GRAFICOS</p>	<p>Hoja: 1 de 15</p>

GRÁFICOS

1. LETREROS

1.1. LETREROS DE SEÑALIZACIÓN - HOMBRES TRABAJANDO.

(ESTRUCTURA METÁLICA, 850 mm de ancho por 1300 mm de alto)

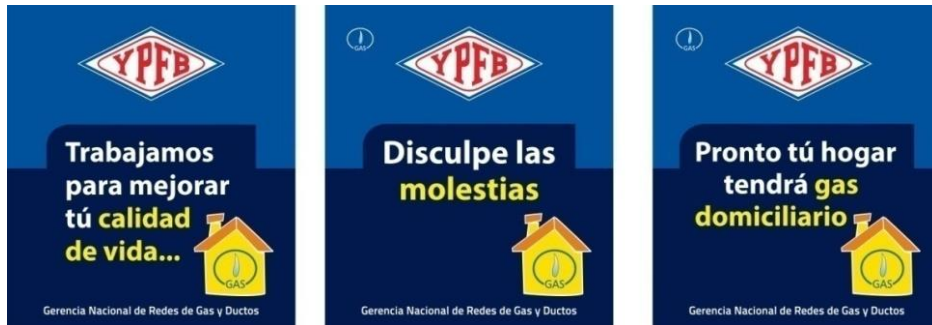

 La fuerza que transforma Bolivia	YACIMIENTOS PETROLIFEROS FISCALES BOLIVIANOS GERENCIA DE REDES DE GAS Y DUCTOS DISTRITO DE REDES DE GAS URURO	Anexo 3
	GRAFICOS	Hoja: 2 de 15

1.2. LETRERO DE OBRA. (De acuerdo a especificación, 2,8 m de ancho por 2,0 mm de alto)

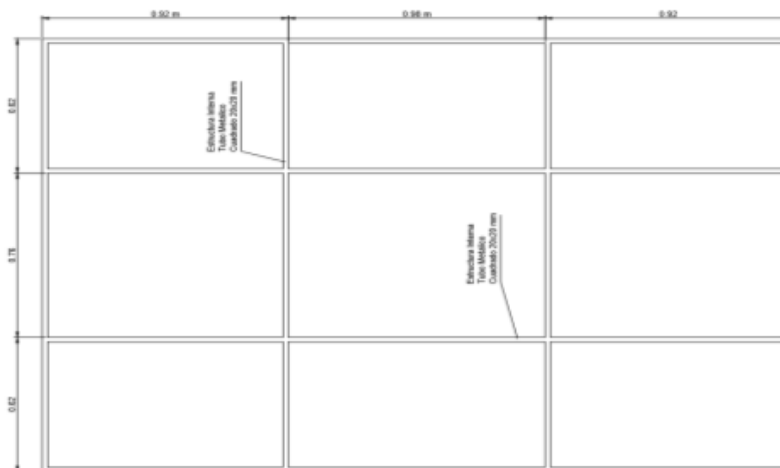

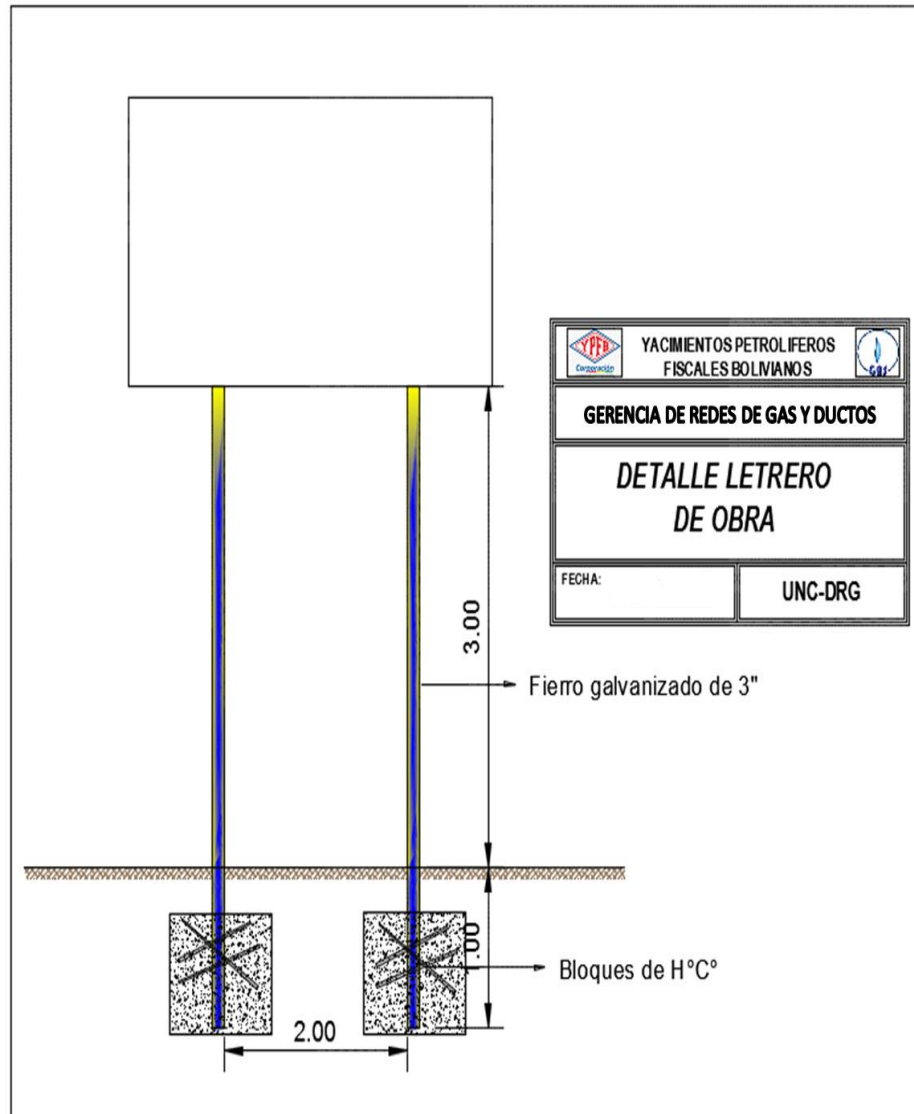

	YACIMIENTOS PETROLIFEROS FISCALES BOLIVIANOS GERENCIA DE REDES DE GAS Y DUCTOS DISTRITO DE REDES DE GAS URUO	Anexo 3
	GRAFICOS	Hoja: 4 de 15

2. EXCAVACIÓN DE ZANJAS

2.1. ACERAS

TERRENO BLANDO

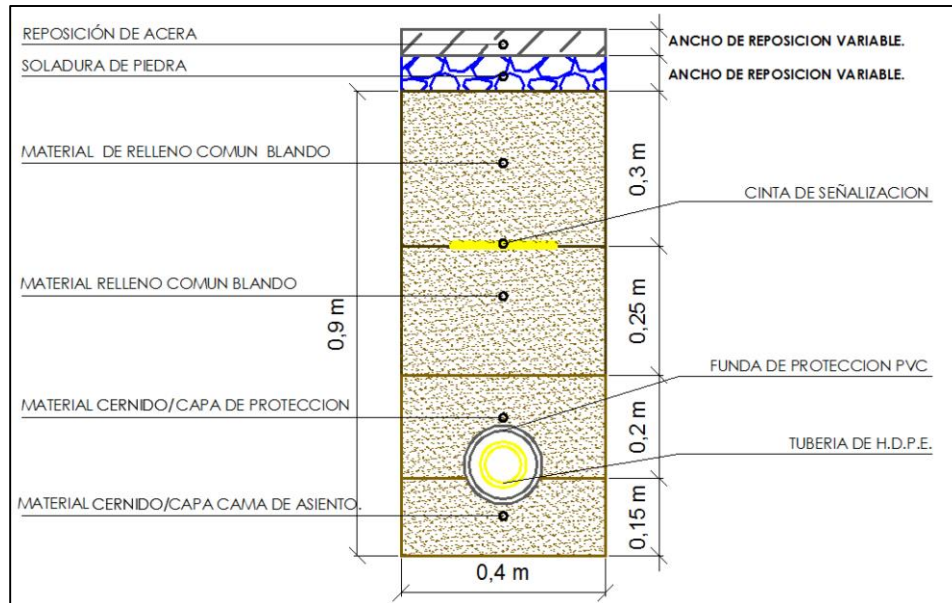

TERRENO SEMIDURO

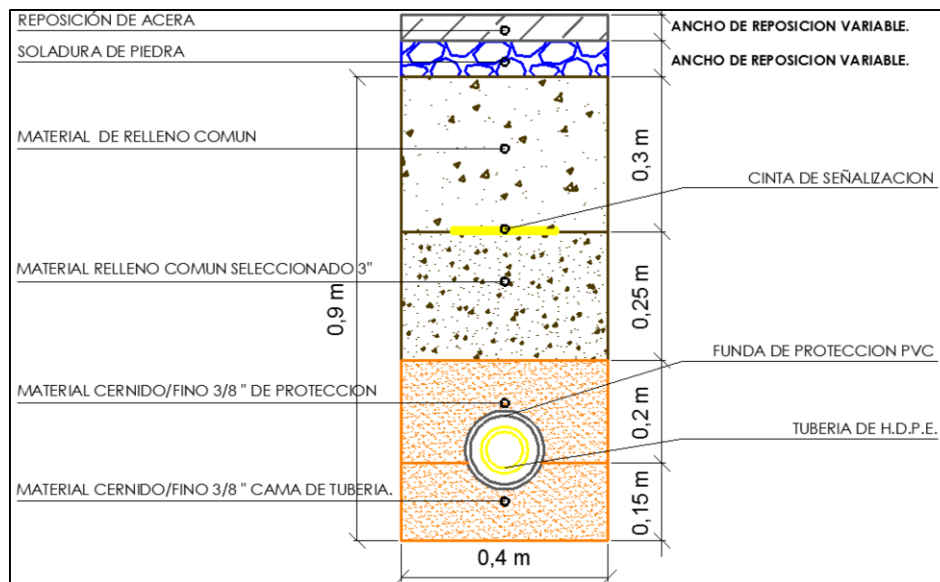

	YACIMIENTOS PETROLIFEROS FISCALES BOLIVIANOS GERENCIA DE REDES DE GAS Y DUCTOS DISTRITO DE REDES DE GAS URUO	Anexo 3
	GRAFICOS	Hoja: 5 de 15

TERRENOS DUROS Y ROCOSOS

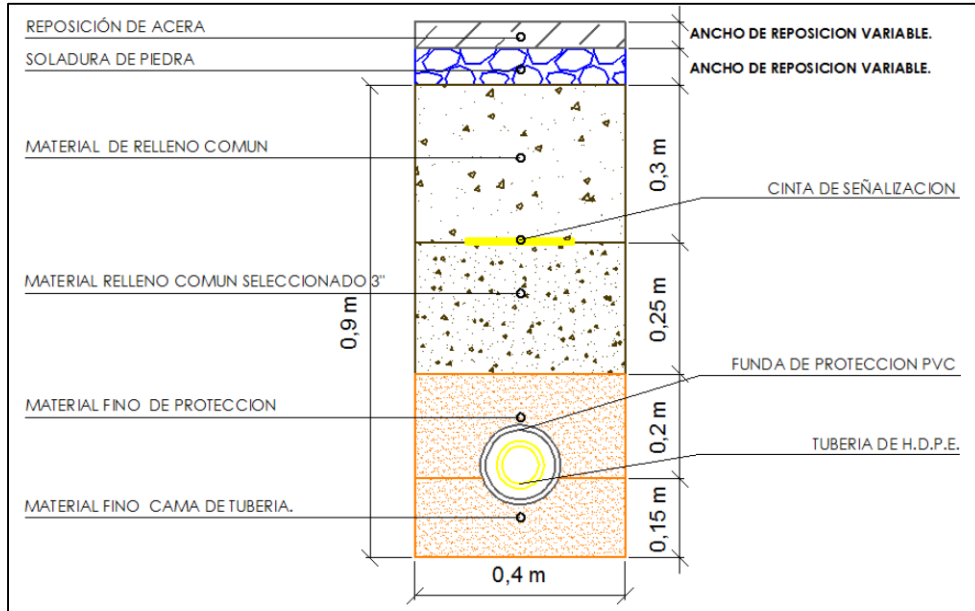

2.2. CALCAZADAS

TERRENO BLANDO

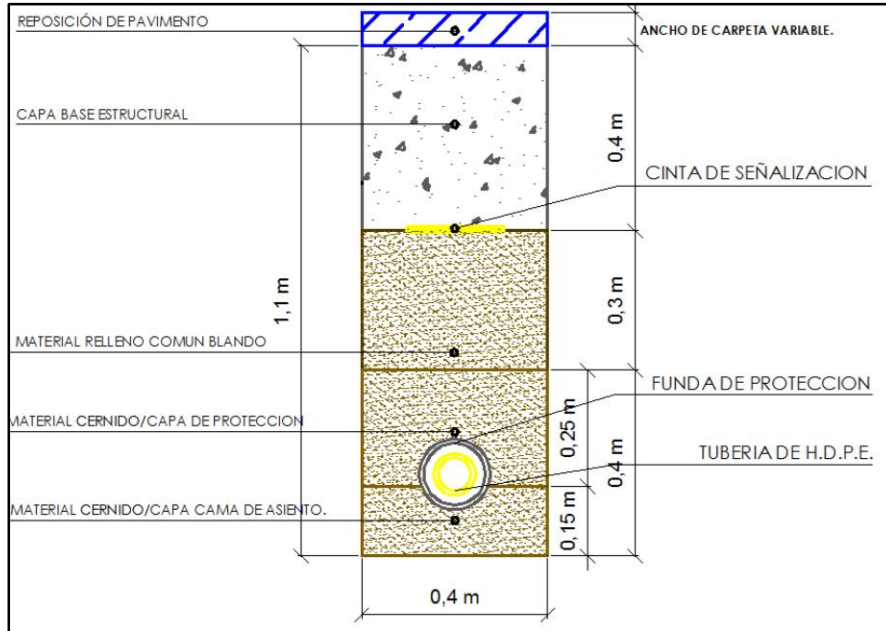

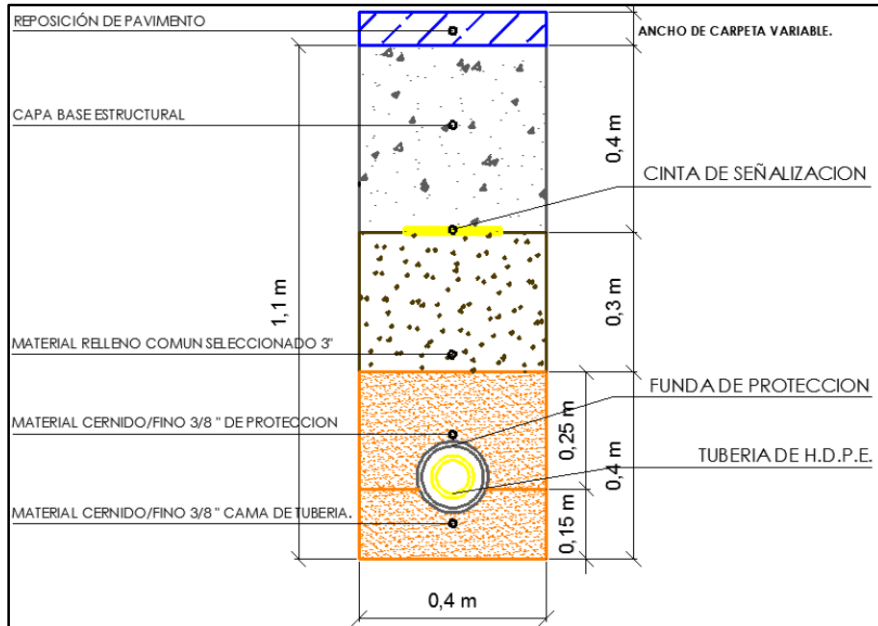

	YACIMIENTOS PETROLIFEROS FISCALES BOLIVIANOS GERENCIA DE REDES DE GAS Y DUCTOS DISTRITO DE REDES DE GAS URUO	Anexo 3
	GRAFICOS	Hoja: 6 de 15

TERRENO SEMIDURO

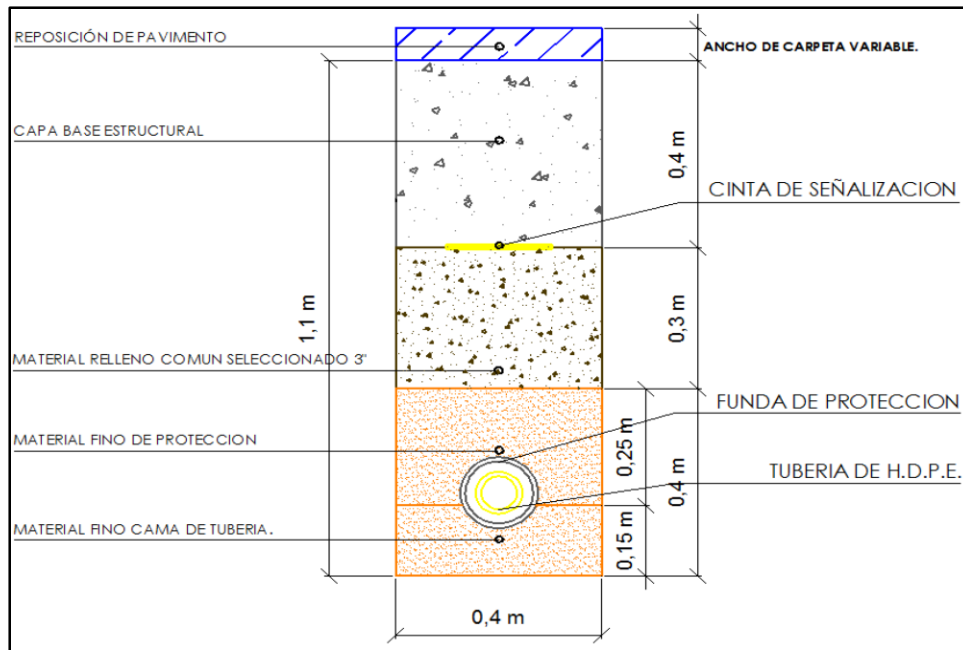

TERRENOS DUROS O ROCOSOS



	YACIMIENTOS PETROLIFEROS FISCALES BOLIVIANOS GERENCIA DE REDES DE GAS Y DUCTOS DISTRITO DE REDES DE GAS ORURO	Anexo 3
	GRAFICOS	Hoja: 7 de 15

3. OBRAS DE FIJACIÓN DE VÁLVULAS Y SEÑALIZACIÓN HORIZONTAL

3.1. BASES DE HORMIGÓN PARA SEÑALIZACIÓN HORIZONTAL EN COBERTURAS DE EMPEDRADO Y TIERRA

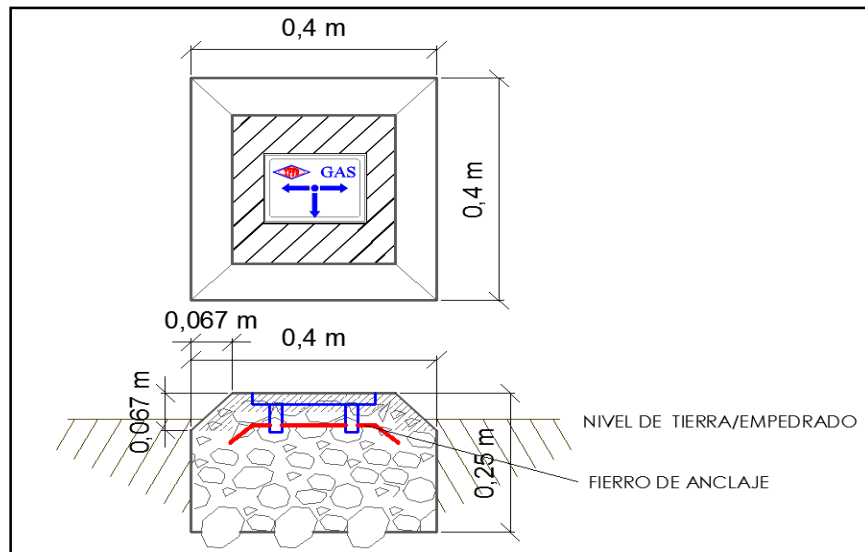

3.2. PLAQUETAS DE SEÑALIZACIÓN HORIZONTAL EN COBERTURAS DE ACERAS DE HORMIGÓN

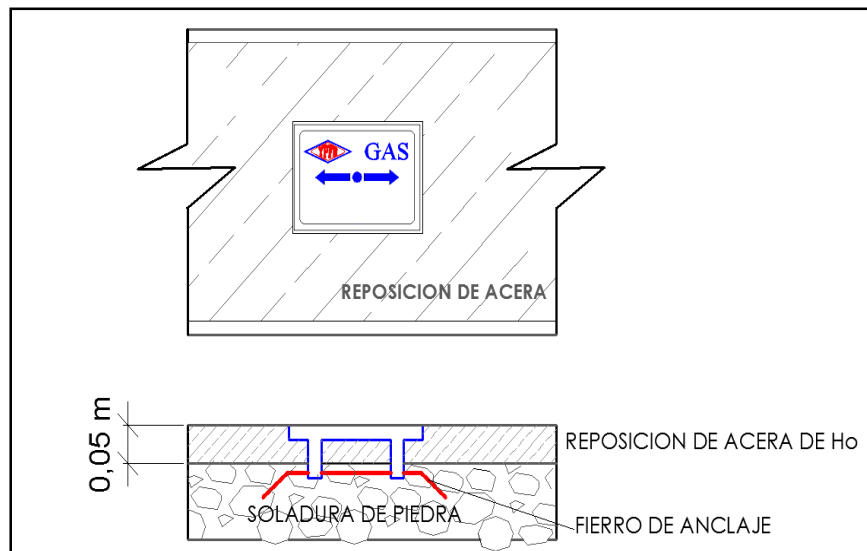

3.3. ESTRUCTURA PARA VÁLVULAS



**YACIMIENTOS PETROLIFEROS FISCALES BOLIVIANOS
GERENCIA DE REDES DE GAS Y DUCTOS
DISTRITO DE REDES DE GAS URURO**

Anexo 3

GRAFICOS

Hoja:
8 de 15

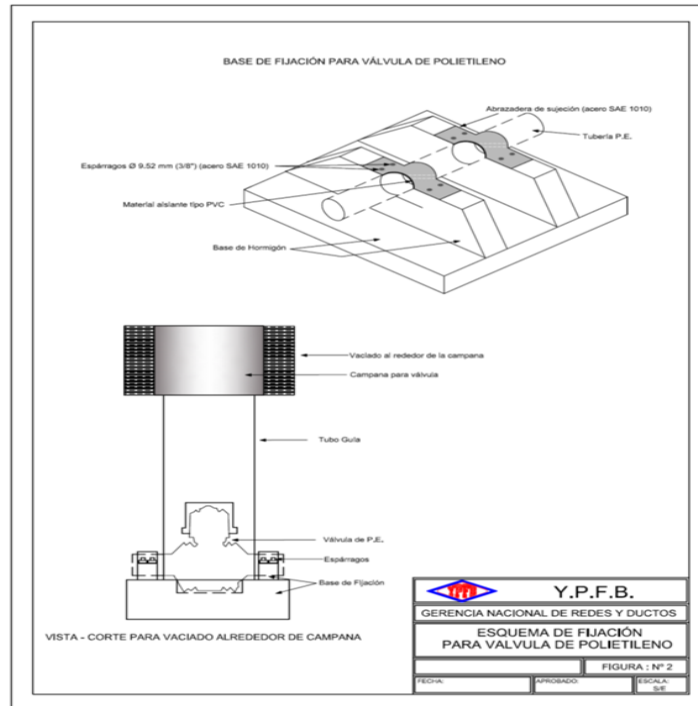
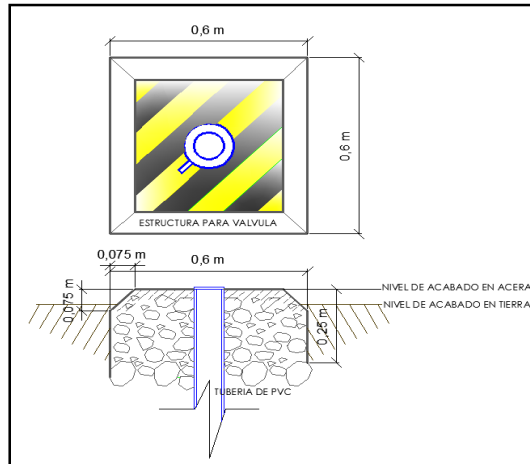

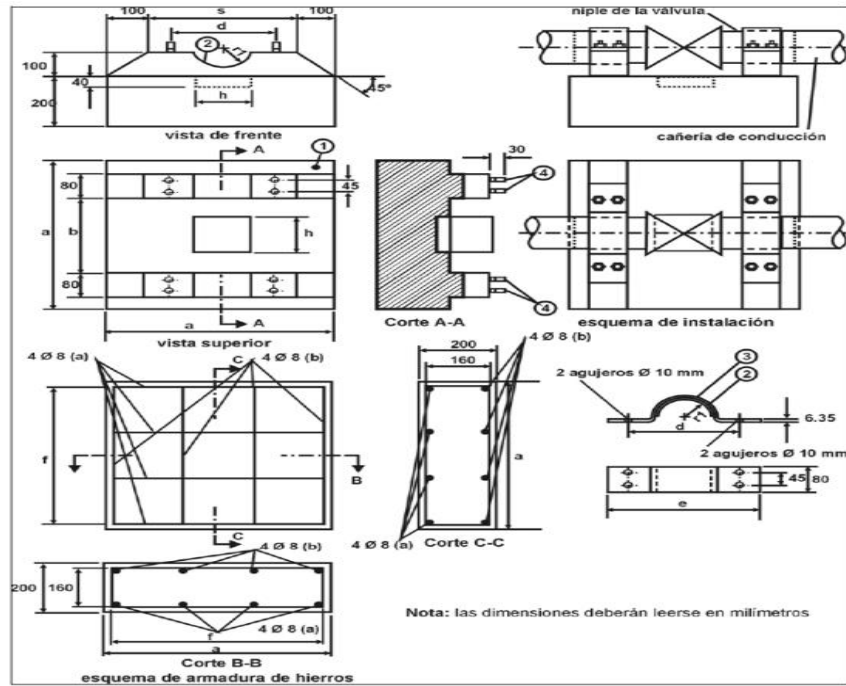

3.4. DETALLE DE LA BASE DE FIJACIÓN DE VÁLVULA DE P.E

Pos.	Denominación	Cantidad
1	Base de hormigón	
2	Material asilante tipo P.V.C.	
3	Abrazadera de sujeción (acero SAE 1010)	2
4	Espárragos \varnothing 9,52 mm (3/8") (acero SAE 1010)	8

Dimensión \varnothing válvula mm.	a	b	c	d	e	f	r	h
mm.	mm.	Esta dimensión será tal que la sujeción se realice sobre el niple de la válvula o la transición de acero	mm.	mm.	mm.	mm.	mm.	mm.
40	267		133	67	93	240	23	123
63	420		210	105	147	378	37	185
90	700		500	140	180	660	47	185
110	700		500	160	200	660	60	211
125	795	568	182	227	750	68	240	

	YACIMIENTOS PETROLIFEROS FISCALES BOLIVIANOS GERENCIA DE REDES DE GAS Y DUCTOS DISTRITO DE REDES DE GAS ORURO	Anexo 3
	GRAFICOS	Hoja: 10 de 15

4. TRANSPORTE Y MANIPULACIÓN DE TUBERÍA

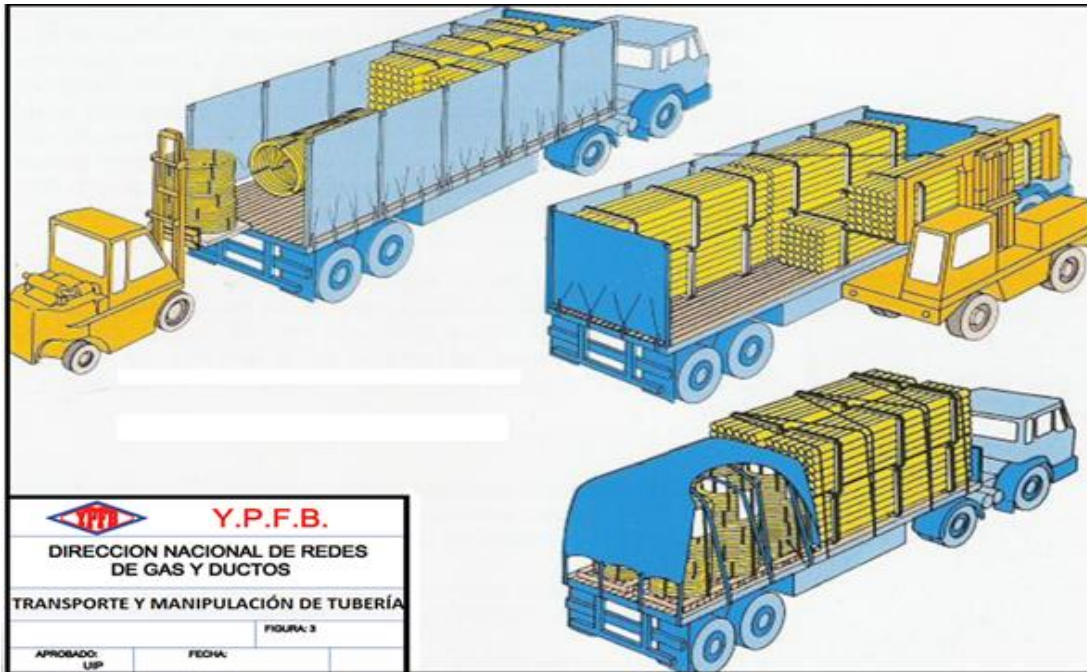

4.1. TRANSPORTE DE TUBERÍA

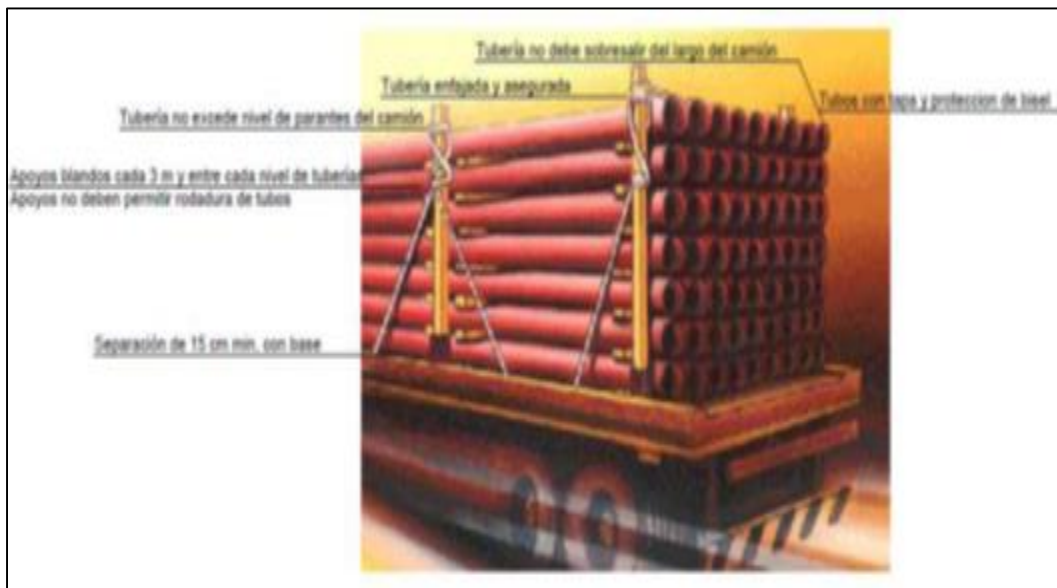

	YACIMIENTOS PETROLIFEROS FISCALES BOLIVIANOS GERENCIA DE REDES DE GAS Y DUCTOS DISTRITO DE REDES DE GAS ORURO	Anexo 3
	GRAFICOS	Hoja: 11 de 15

4.2. ALMACENAJE DE TUBERÍA



5. REPOSICIONES EN ACERA

5.1. ACERAS DE HORMIGÓN.

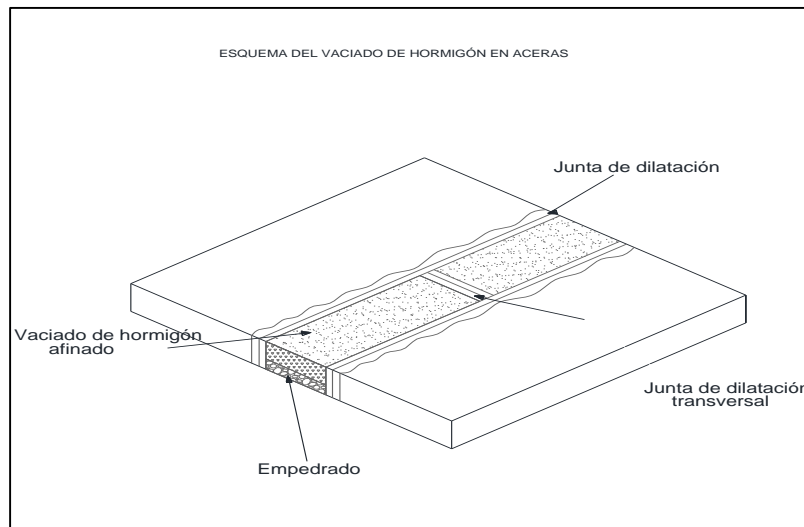

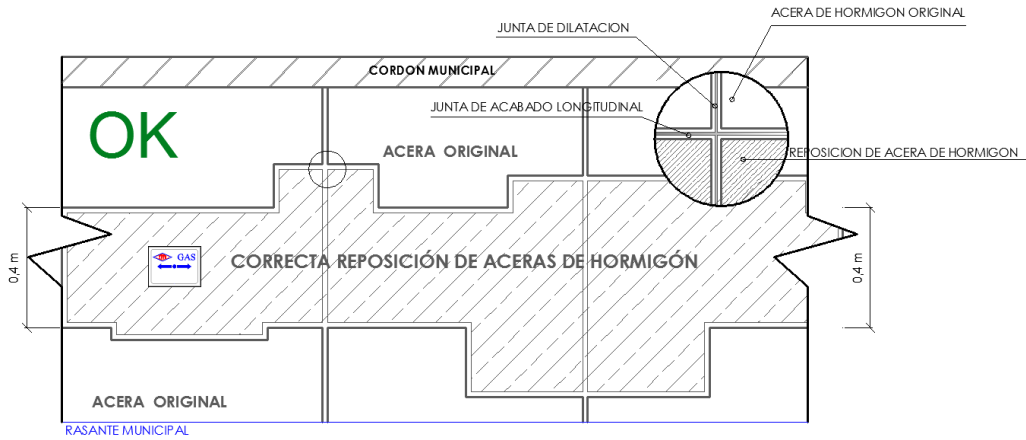
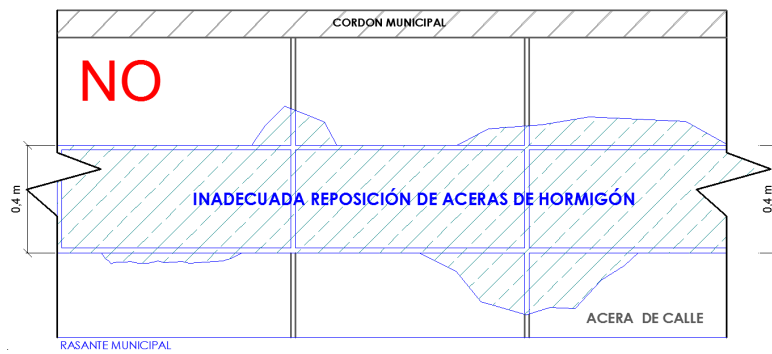
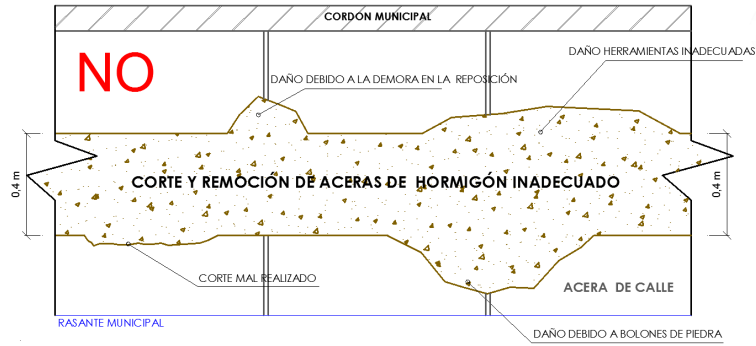

	YACIMIENTOS PETROLIFEROS FISCALES BOLIVIANOS GERENCIA DE REDES DE GAS Y DUCTOS DISTRITO DE REDES DE GAS ORURO	Anexo 3
	GRAFICOS	Hoja: 13 de 15

6. LASTRADO DE TUBERIA.

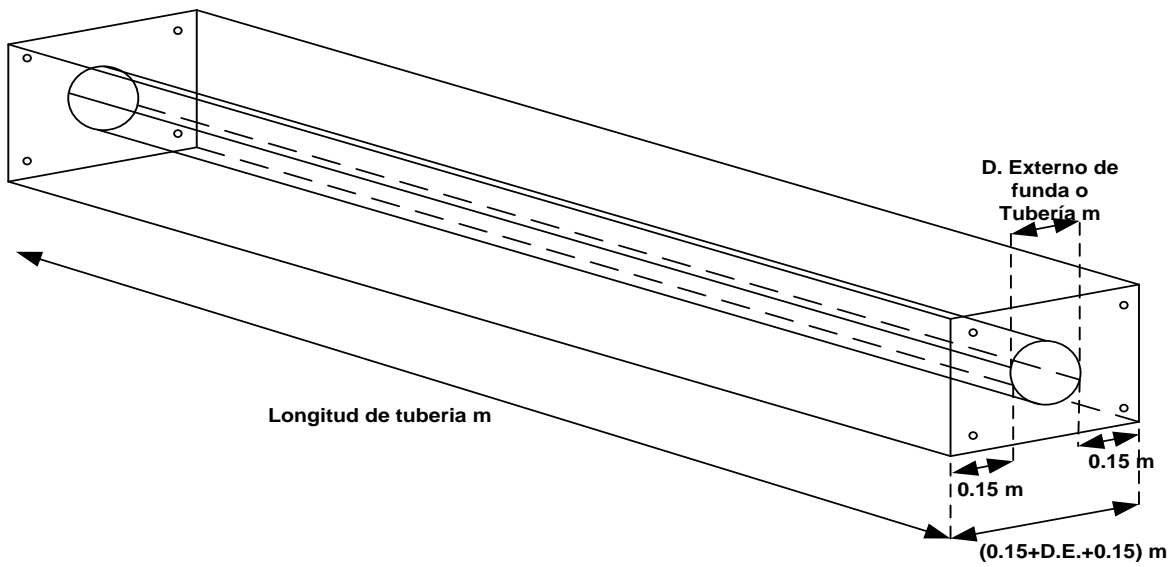
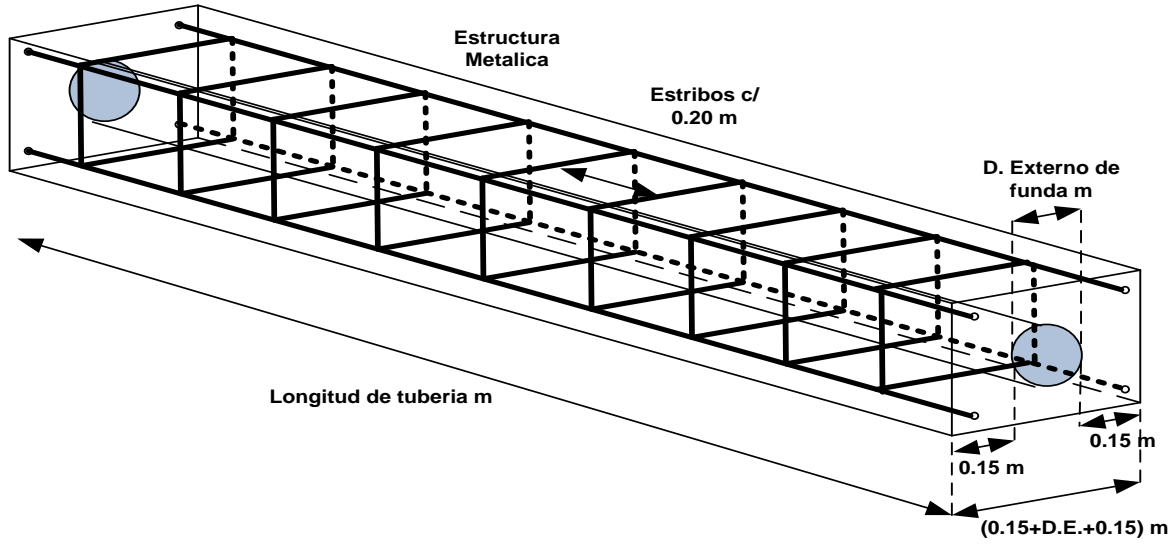

	<p align="center">YACIMIENTOS PETROLIFEROS FISCALES BOLIVIANOS GERENCIA DE REDES DE GAS Y DUCTOS DISTRITO DE REDES DE GAS ORURO</p>	<p align="center">Anexo 3</p>
	<p align="center">GRAFICOS</p>	<p>Hoja: 14 de 15</p>

7. SOLDADURA POR ELECTROFUSIÓN

8.1. CORRECTA UNIÓN A ENCHUFE POR *ELECTROFUSIÓN*

Figura 1. Aspecto de una correcta unión a enchufe por *electrofusión*.

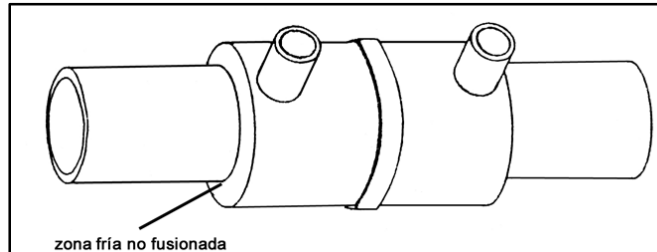

8.2. INCORRECTA UNIÓN A ENCHUFE POR *ELECTROFUSIÓN*

Figura 2. Penetración inadecuada de los tubos en el accesorio.



Figura 3. Penetración incompleta de uno de los tubos en el accesorio.



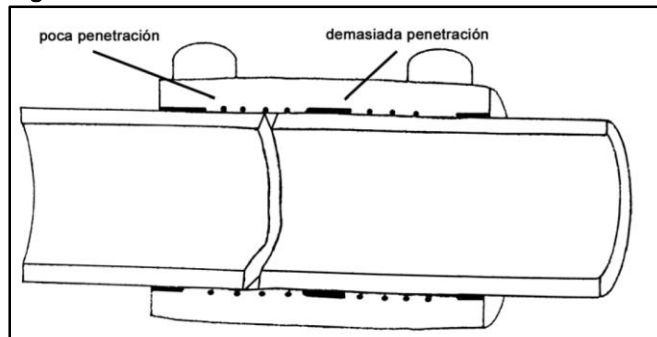

Figura 4. Áreas sin fusionar debido a superficies sin preparación adecuada.

	YACIMIENTOS PETROLIFEROS FISCALES BOLIVIANOS GERENCIA DE REDES DE GAS Y DUCTOS DISTRITO DE REDES DE GAS ORURO	Anexo 3
	GRAFICOS	Hoja: 15 de 15

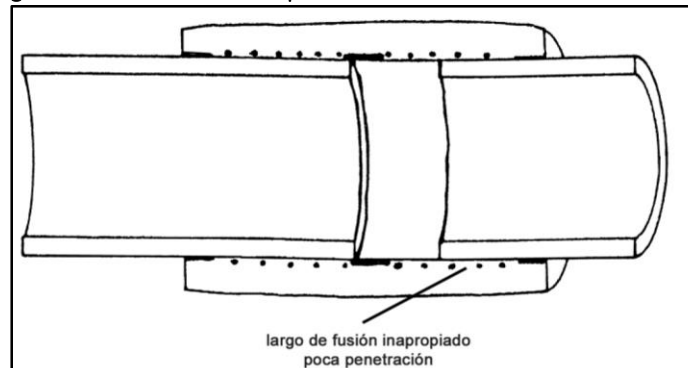
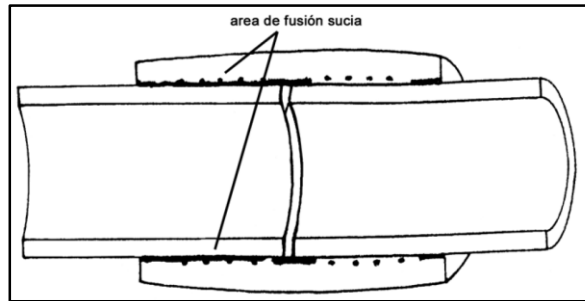

Figura 5. Alineación defectuosa.

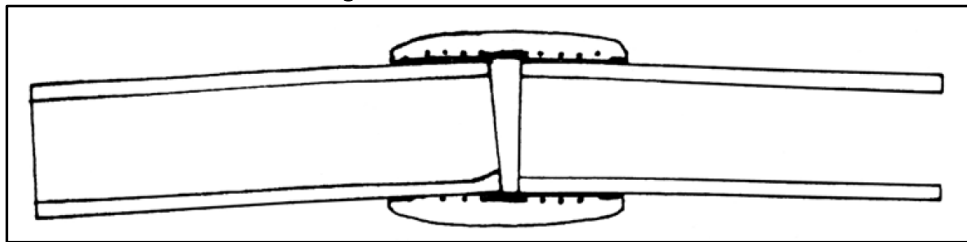

Fecha: Oruro, 23 de Agosto de 2019